

Wings: 1 piece
1:1 scale, 5'7" (1.7 m) height



If printing to A₄ paper, please refer to
the separate printing instructions.

Combat Medic Ziegler (Insurrection Mercy Skin)

Original 3d Model by Blizzard

Vectors drawn by Sara McMunn



CestLaSara



Lasarabande

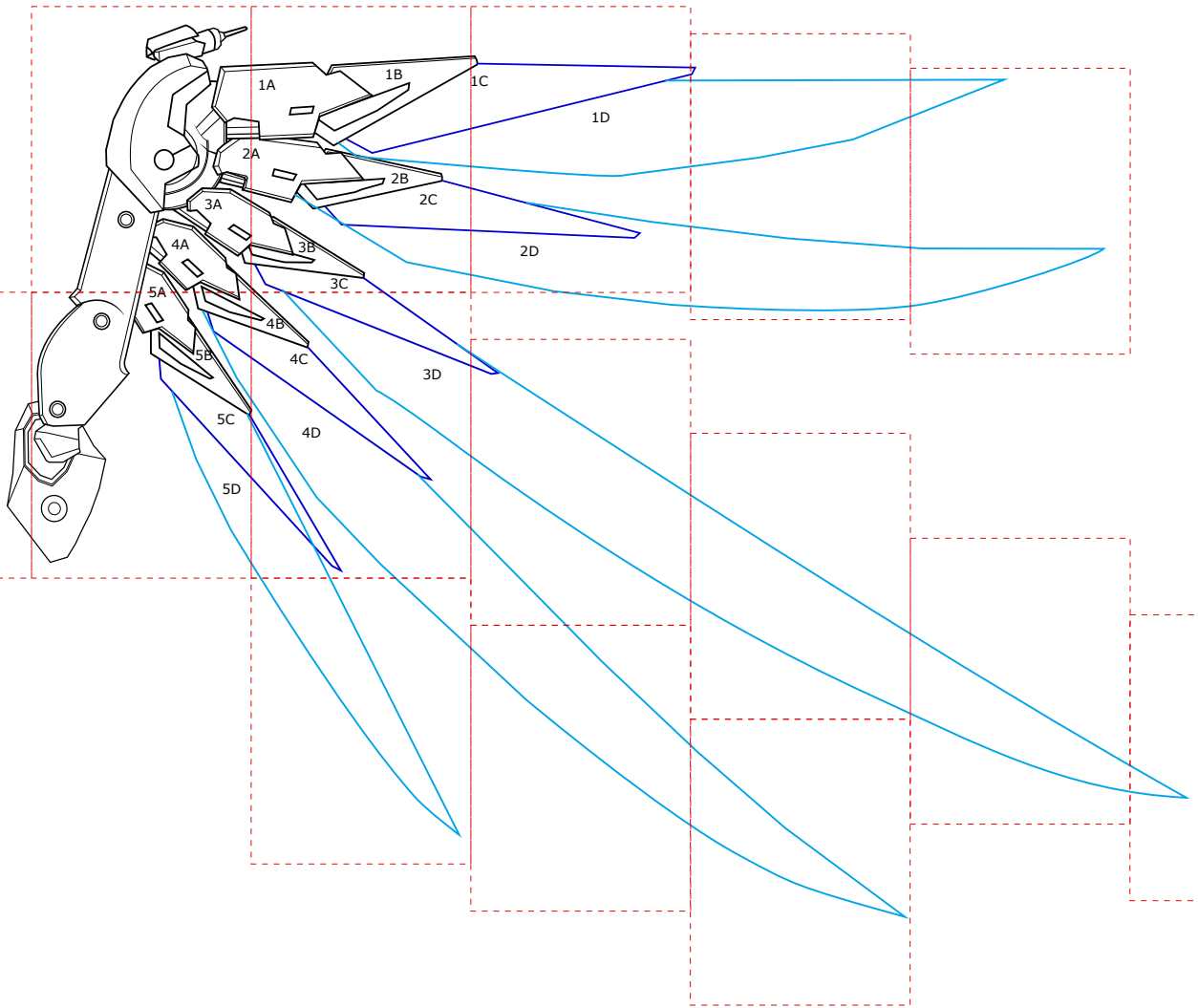

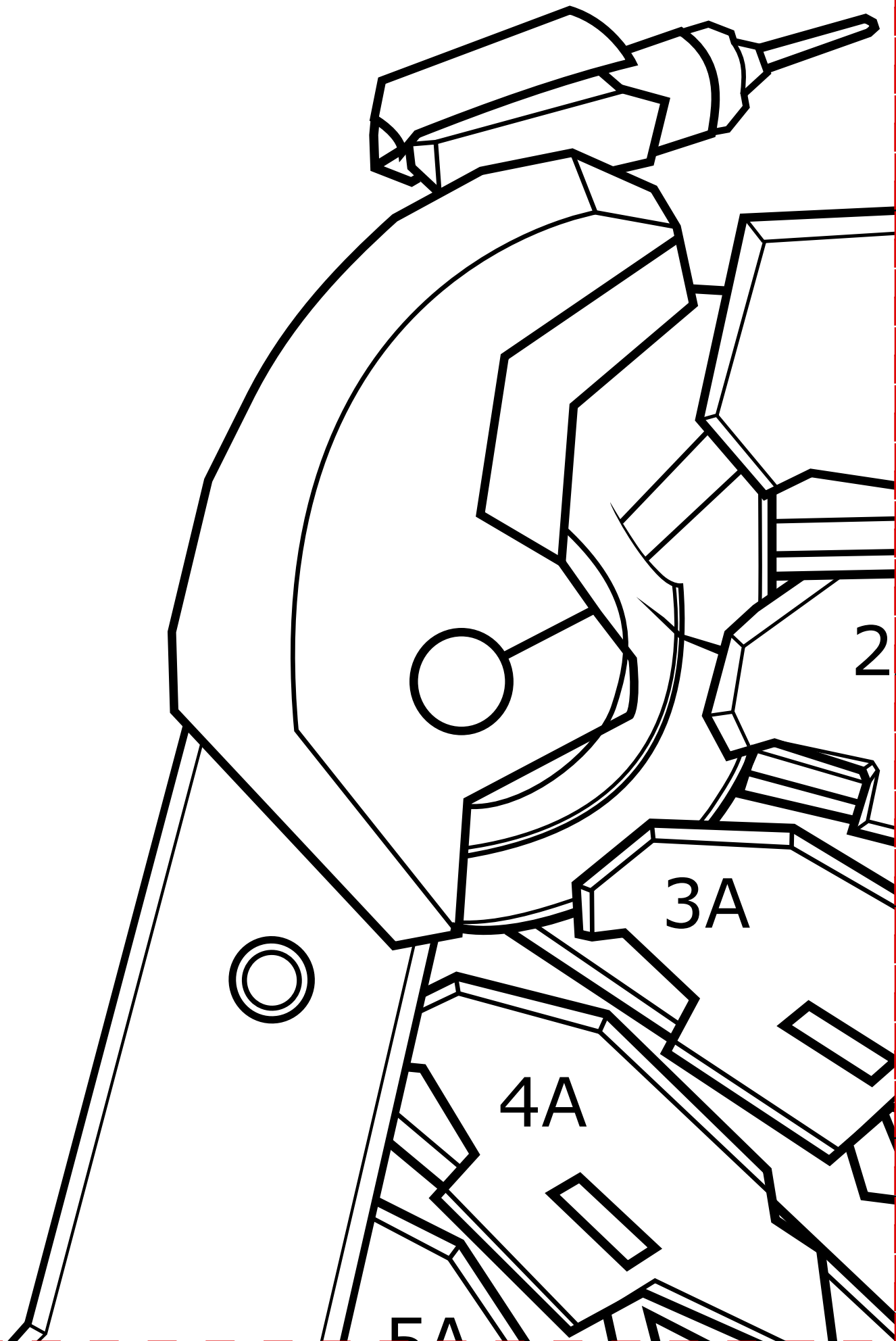

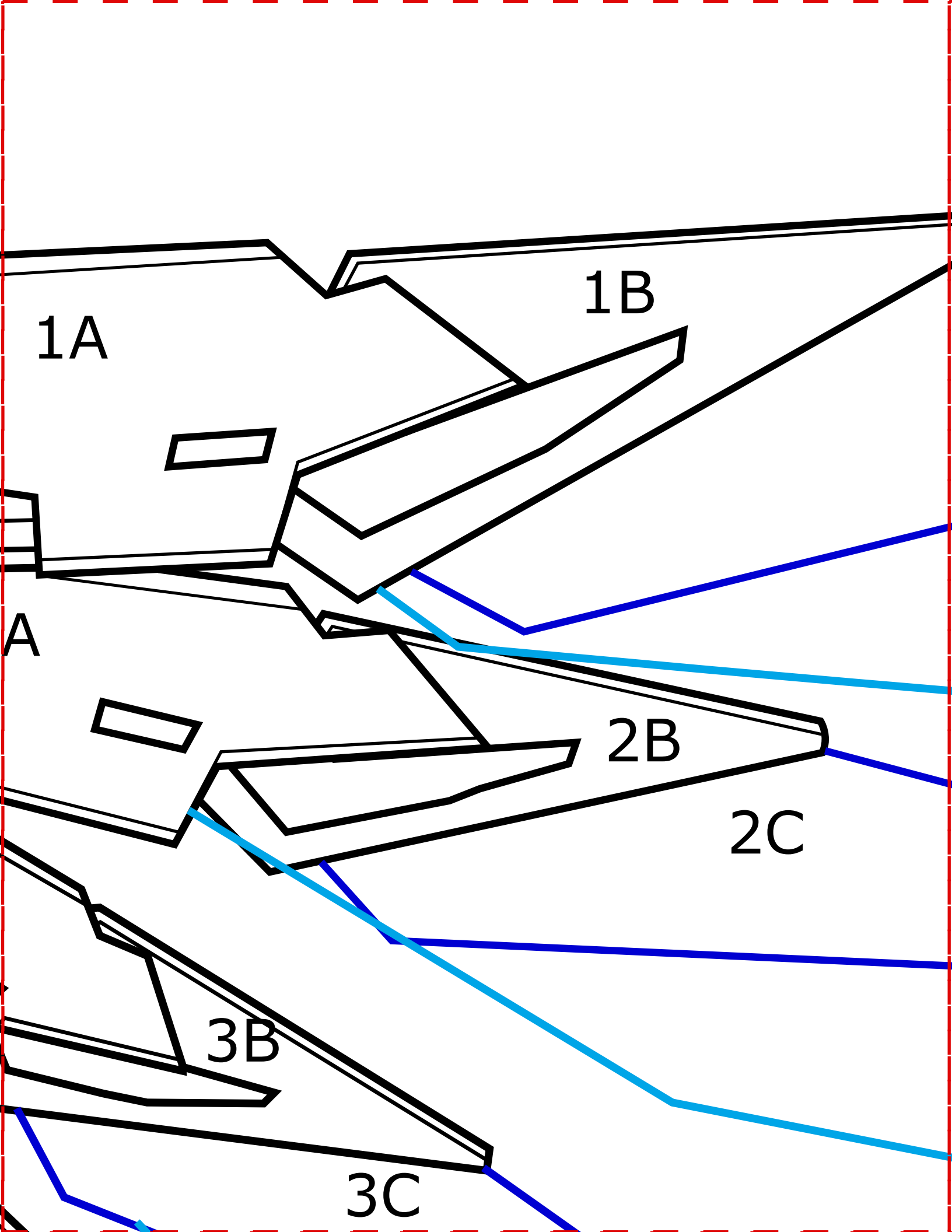

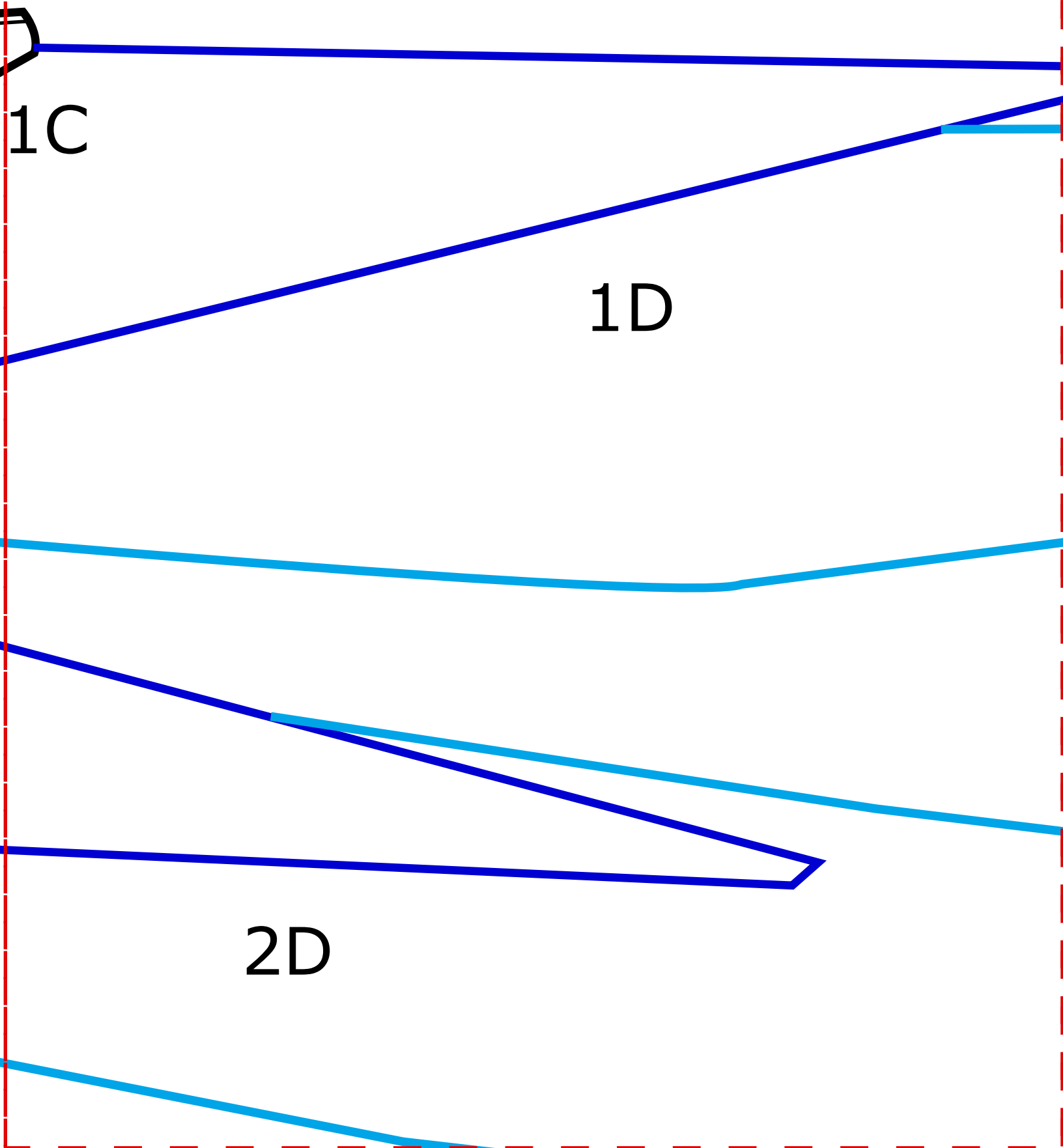



A solid blue horizontal line spanning the width of the page.

A solid blue line that starts at the left edge and trends upwards to the right edge.

A solid blue line that starts at the left edge and trends downwards to the right edge.

A solid blue line that starts at the left edge, dips slightly, and then trends slightly upwards to the right edge.

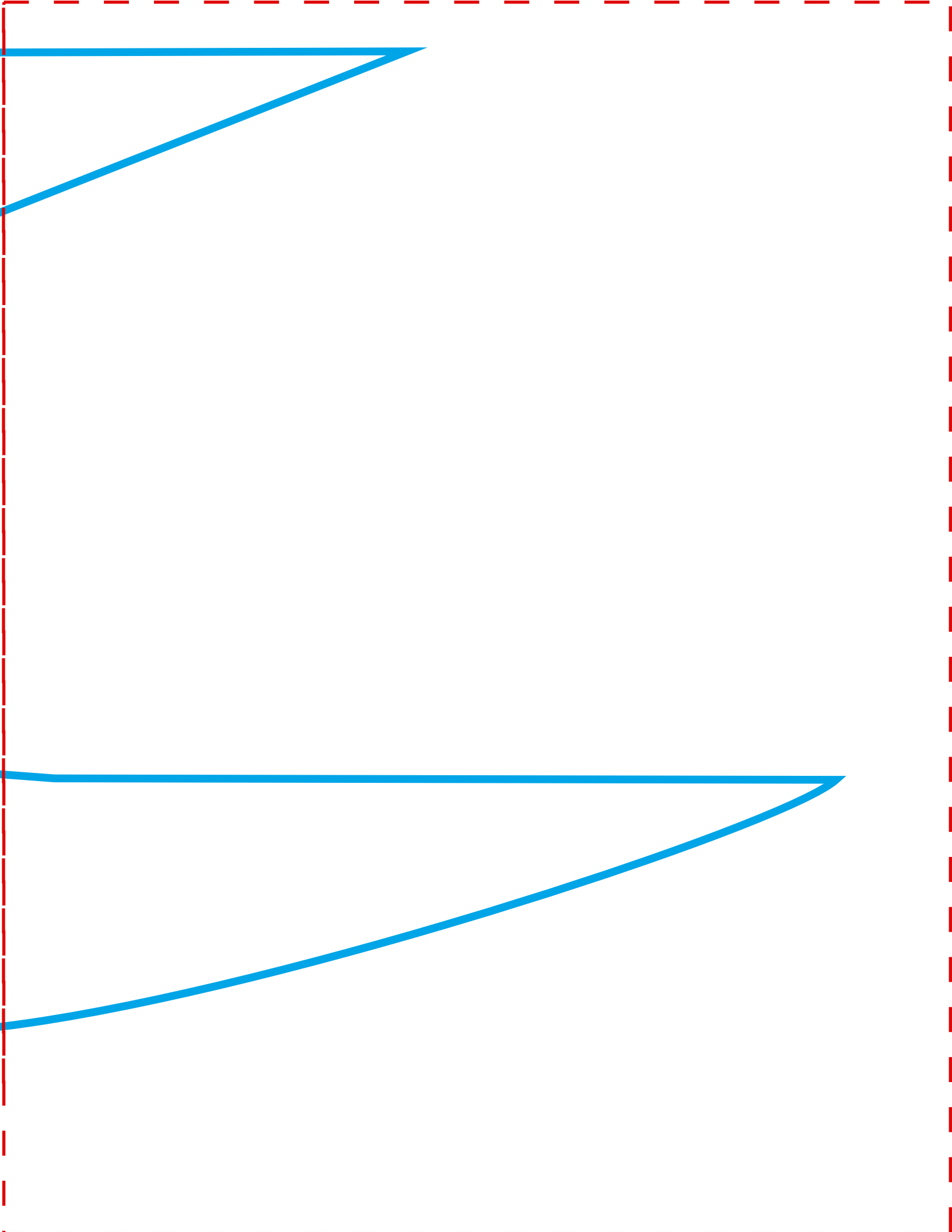

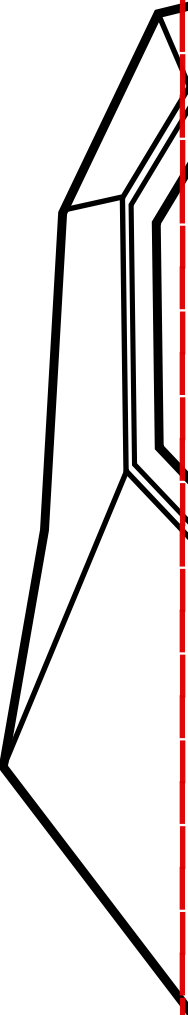

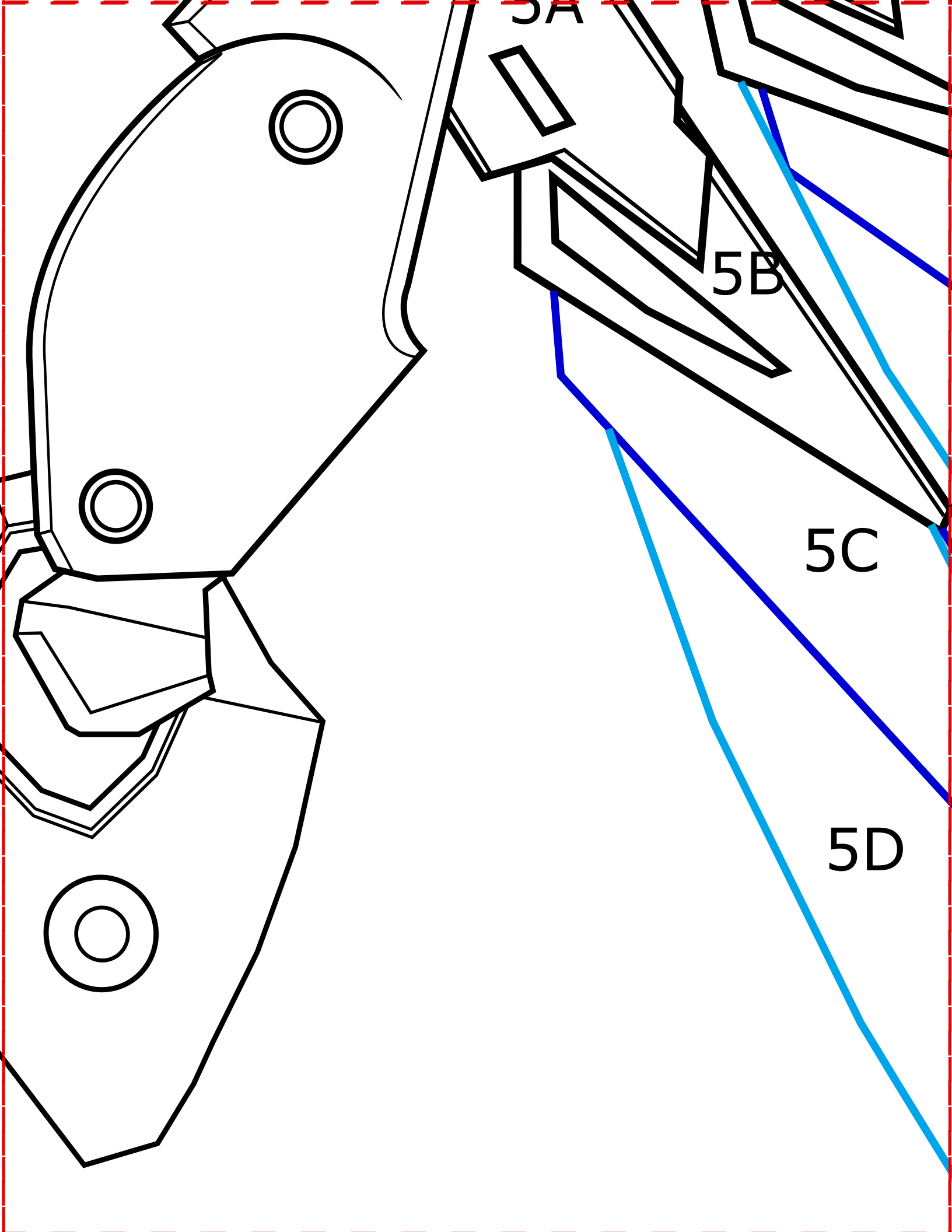

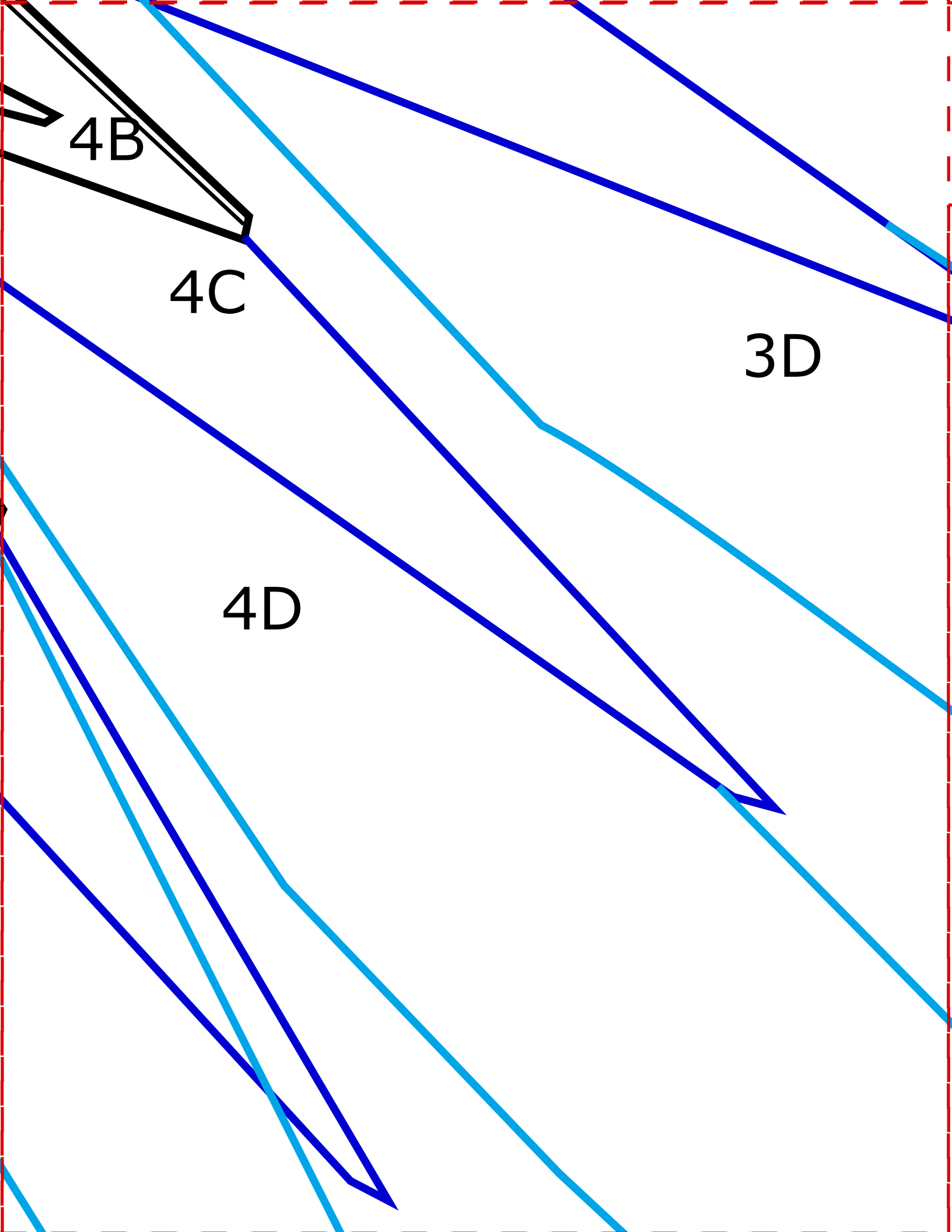

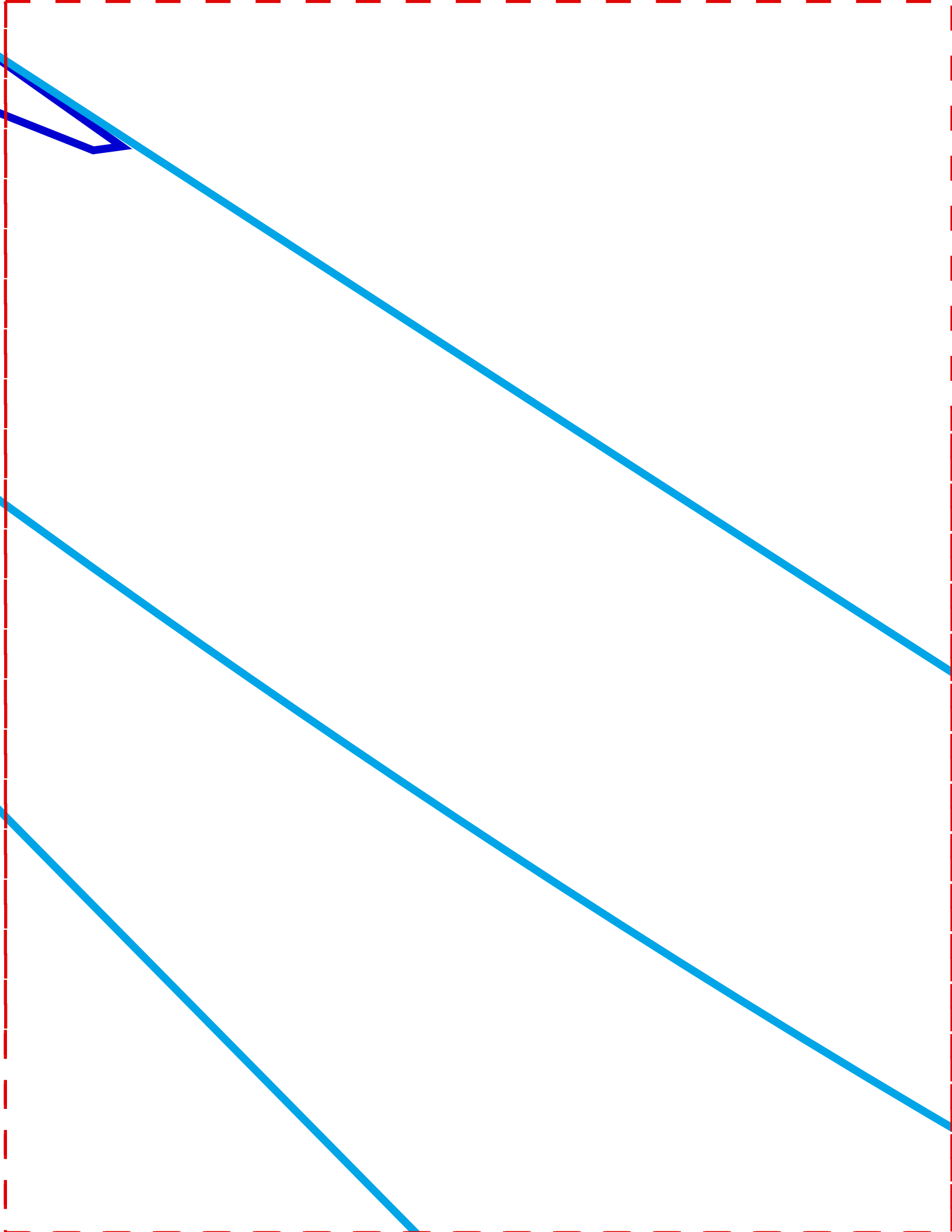

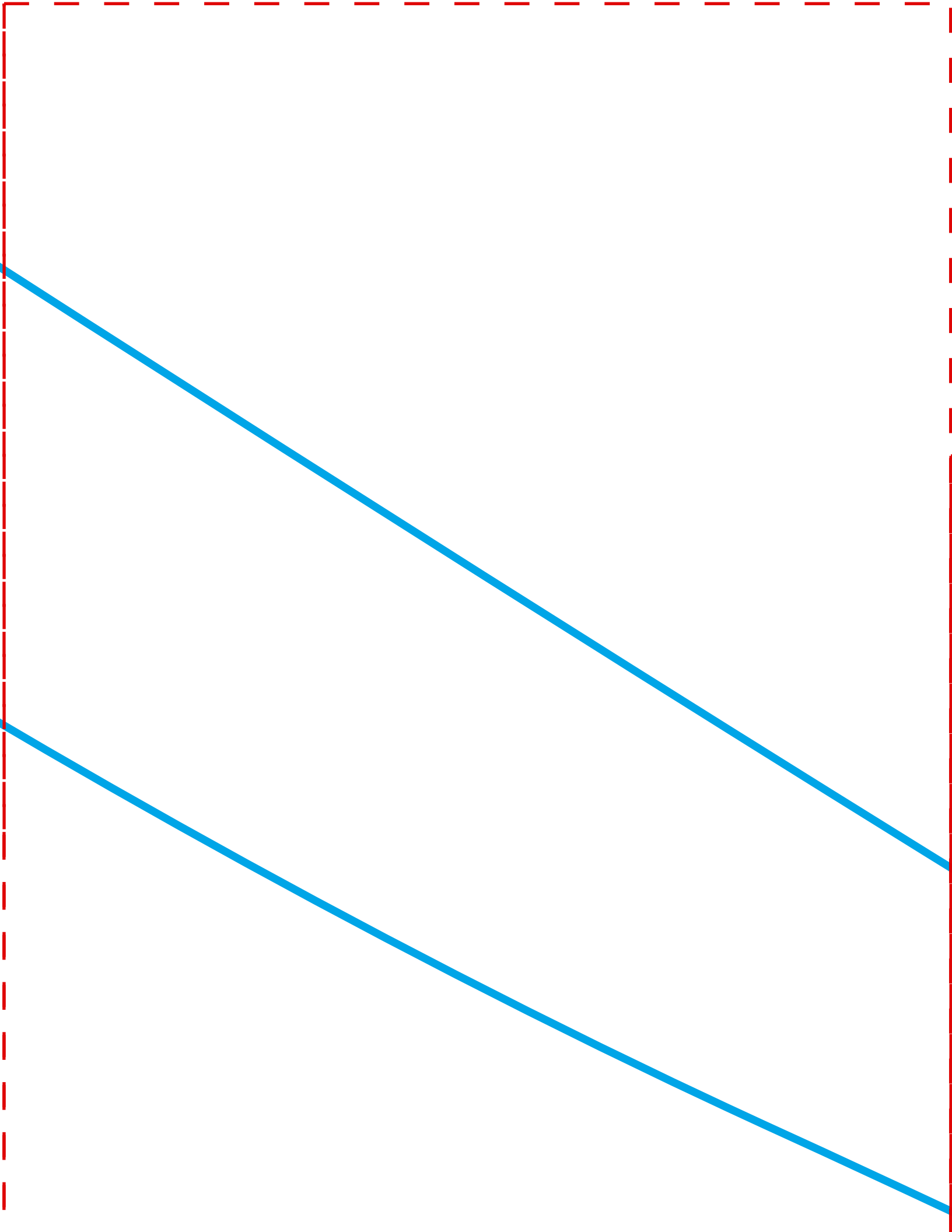

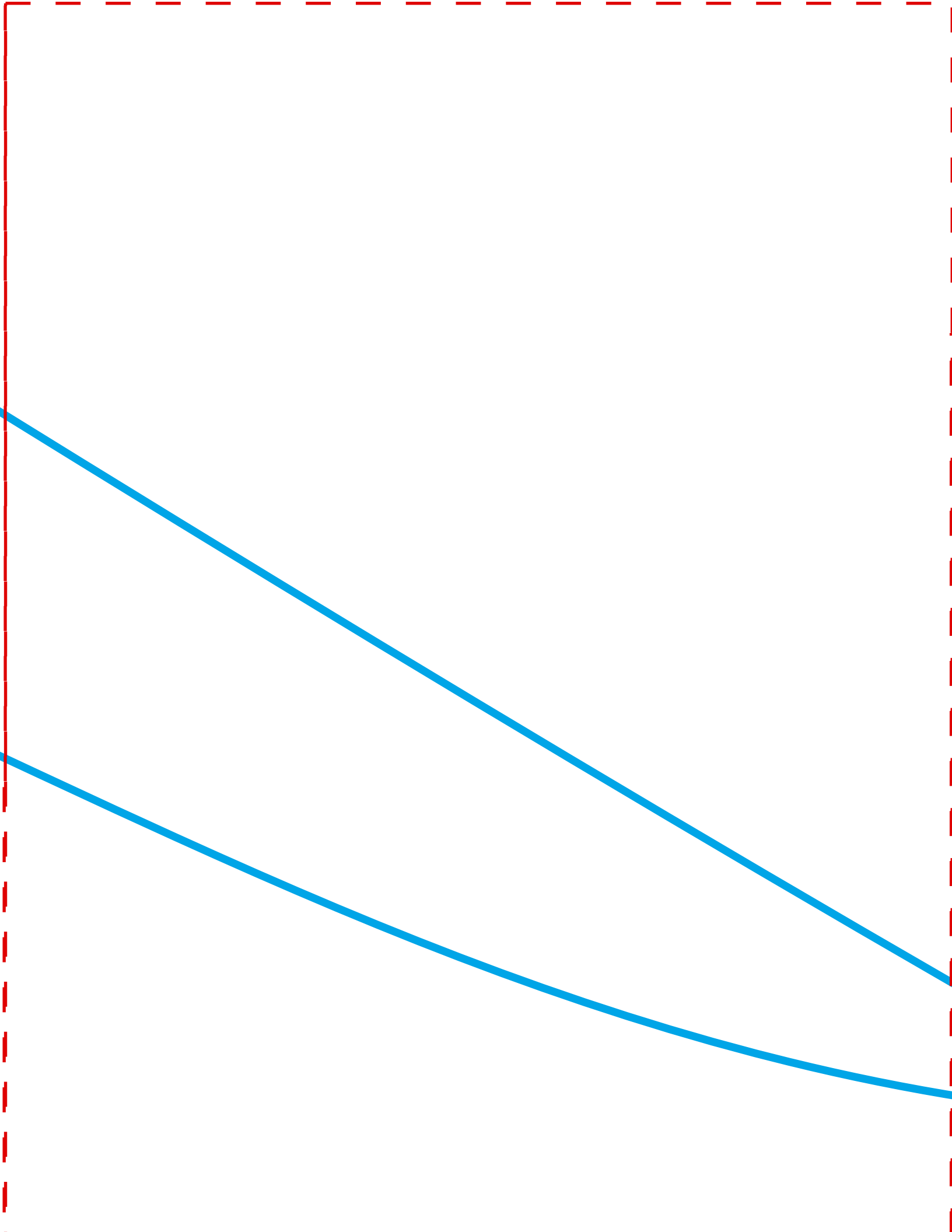

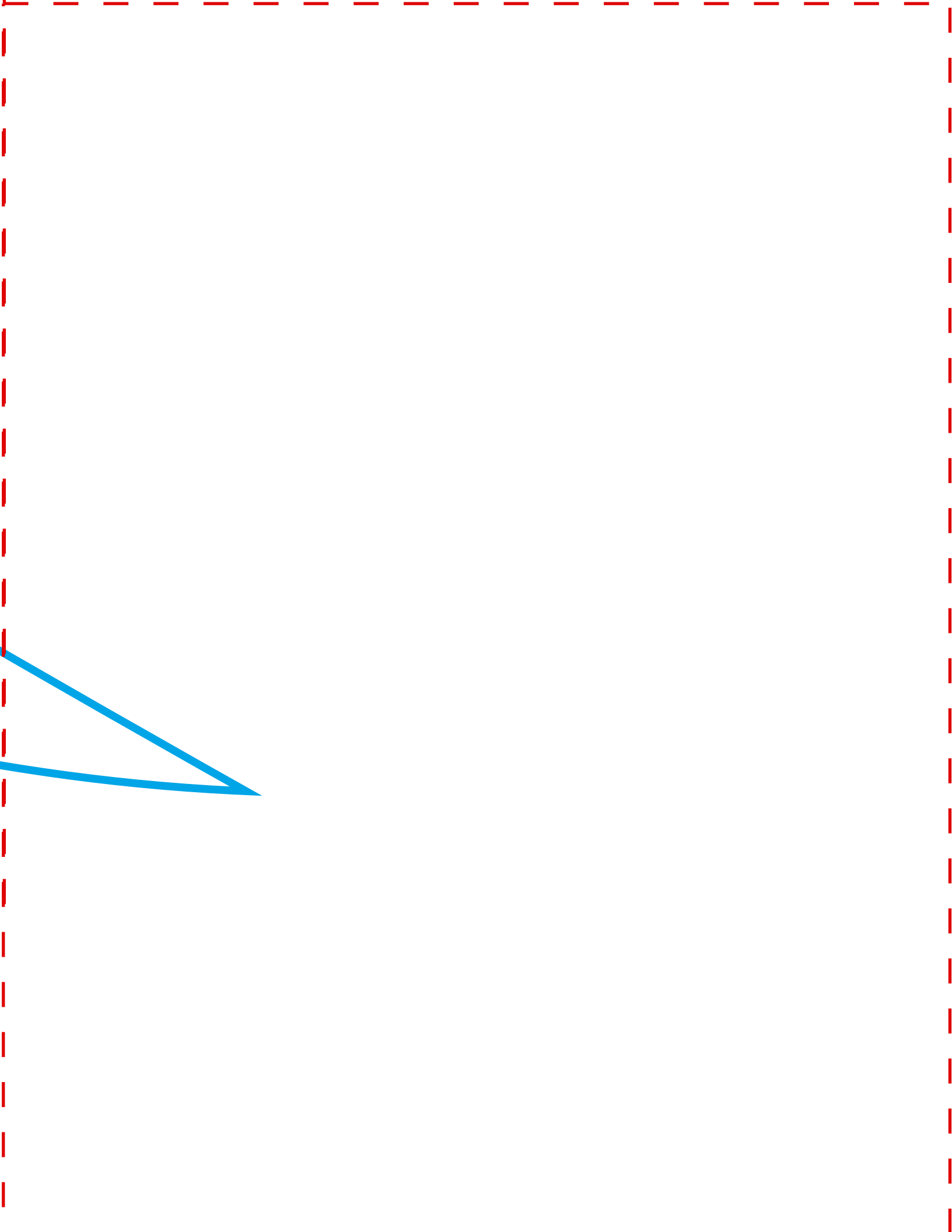

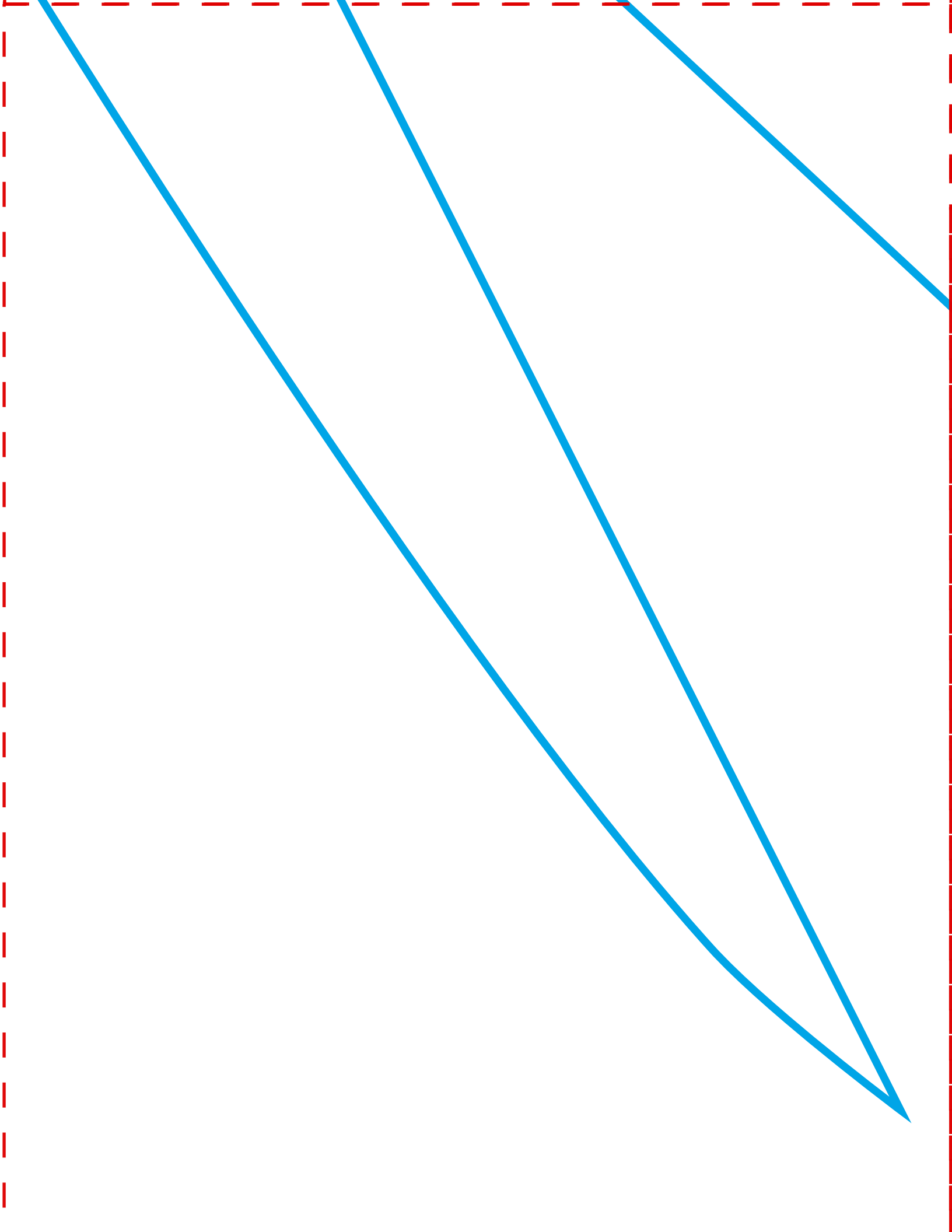

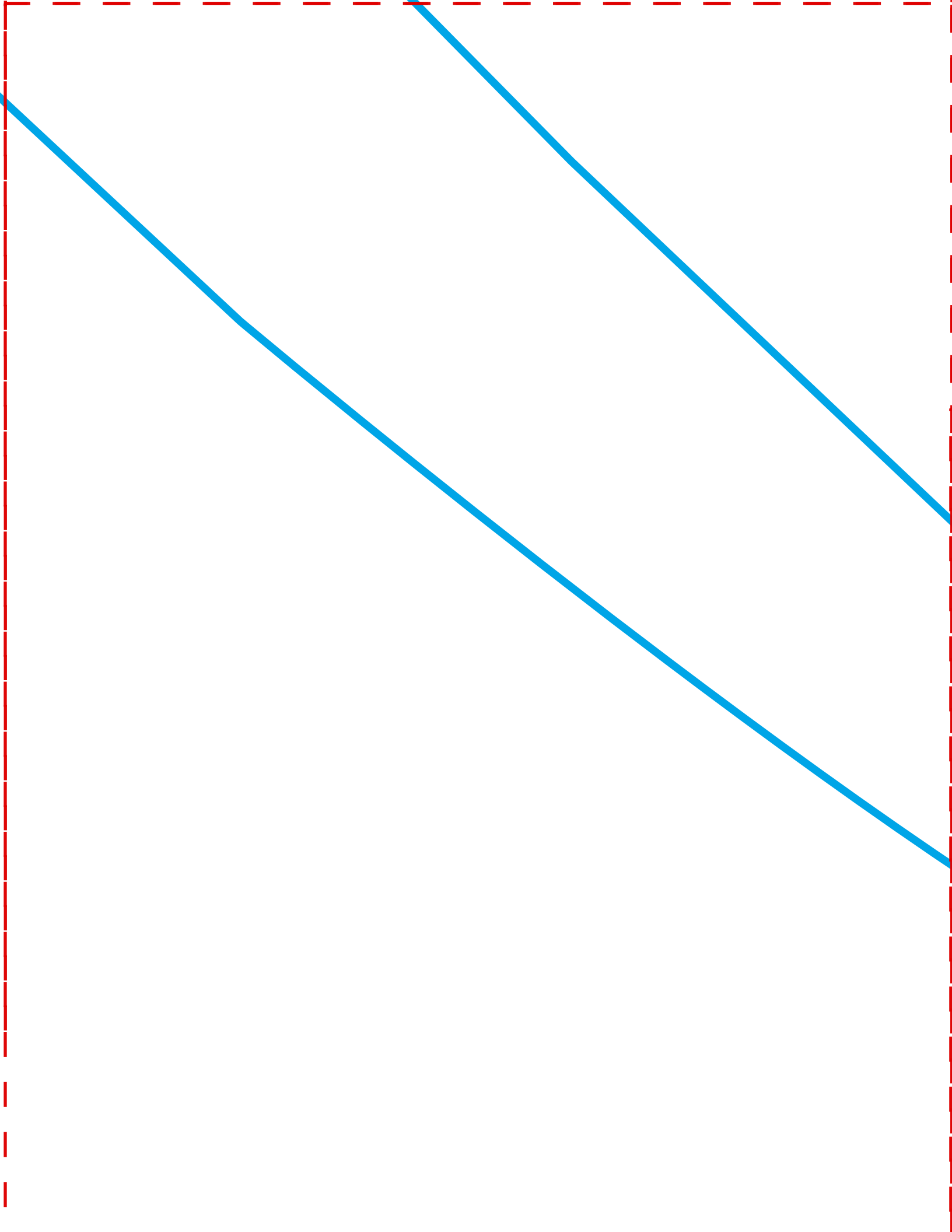

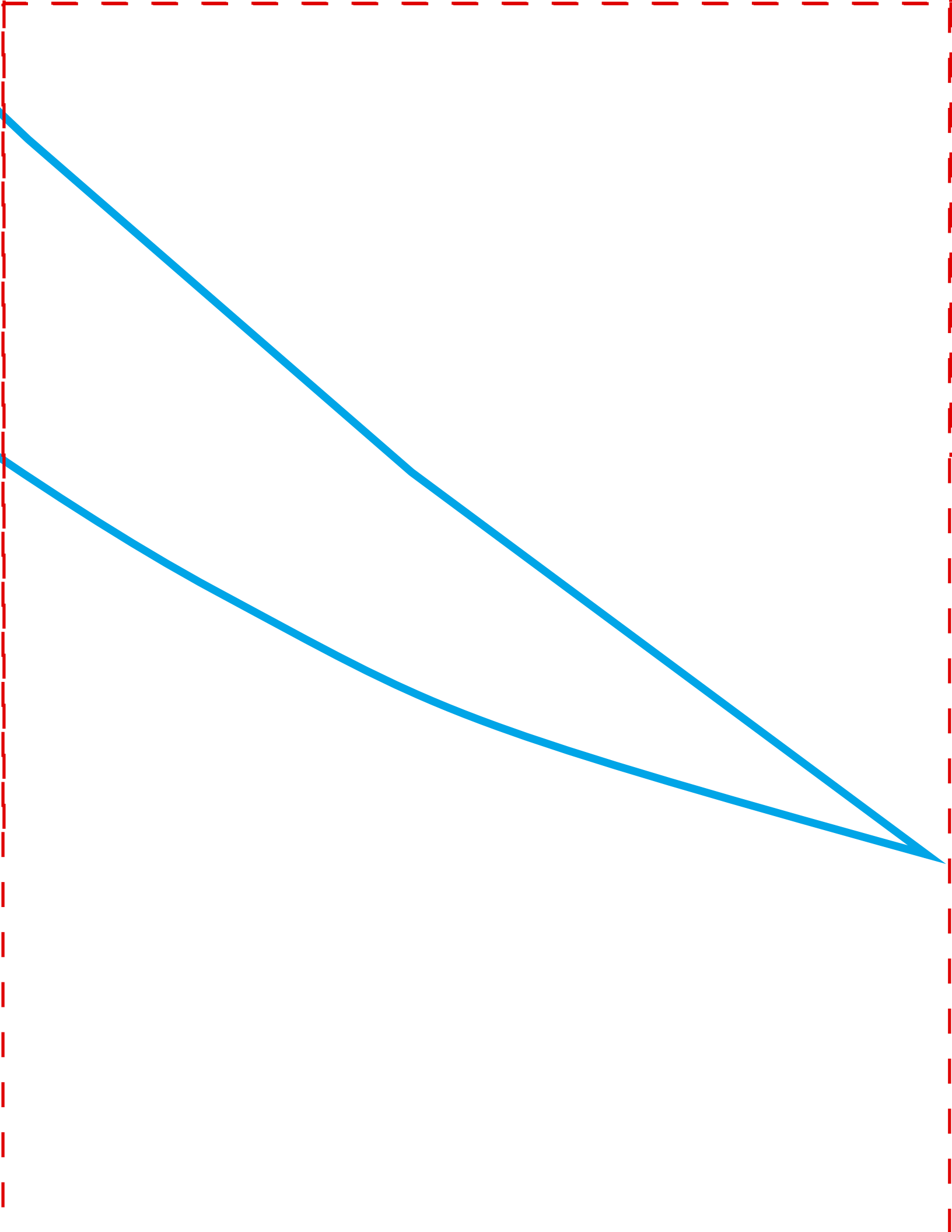

Wings by Section

1:1 scale, 5'7" (1.7 m) height

If printing to A4 paper, please refer to
the separate printing instructions.

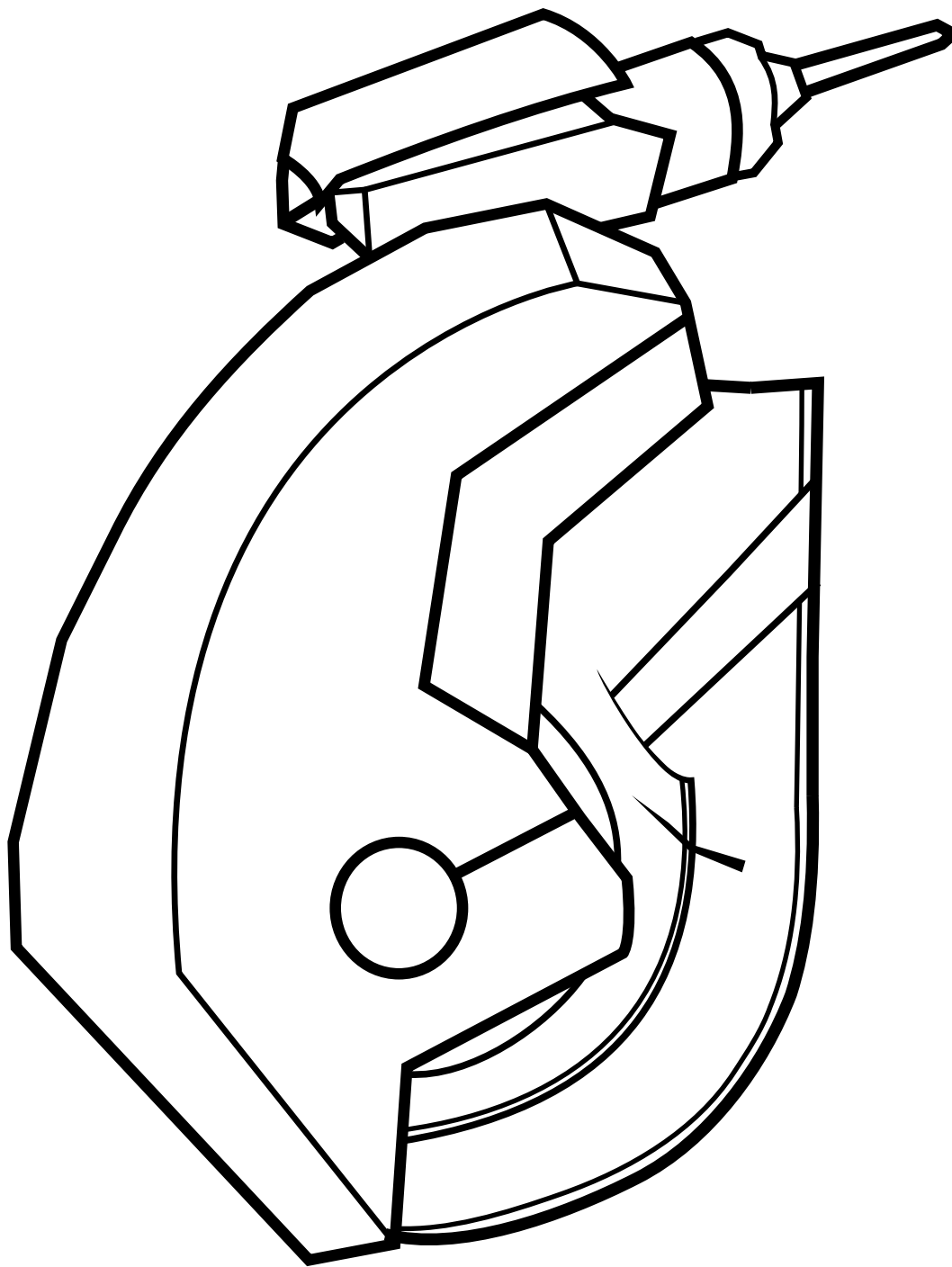

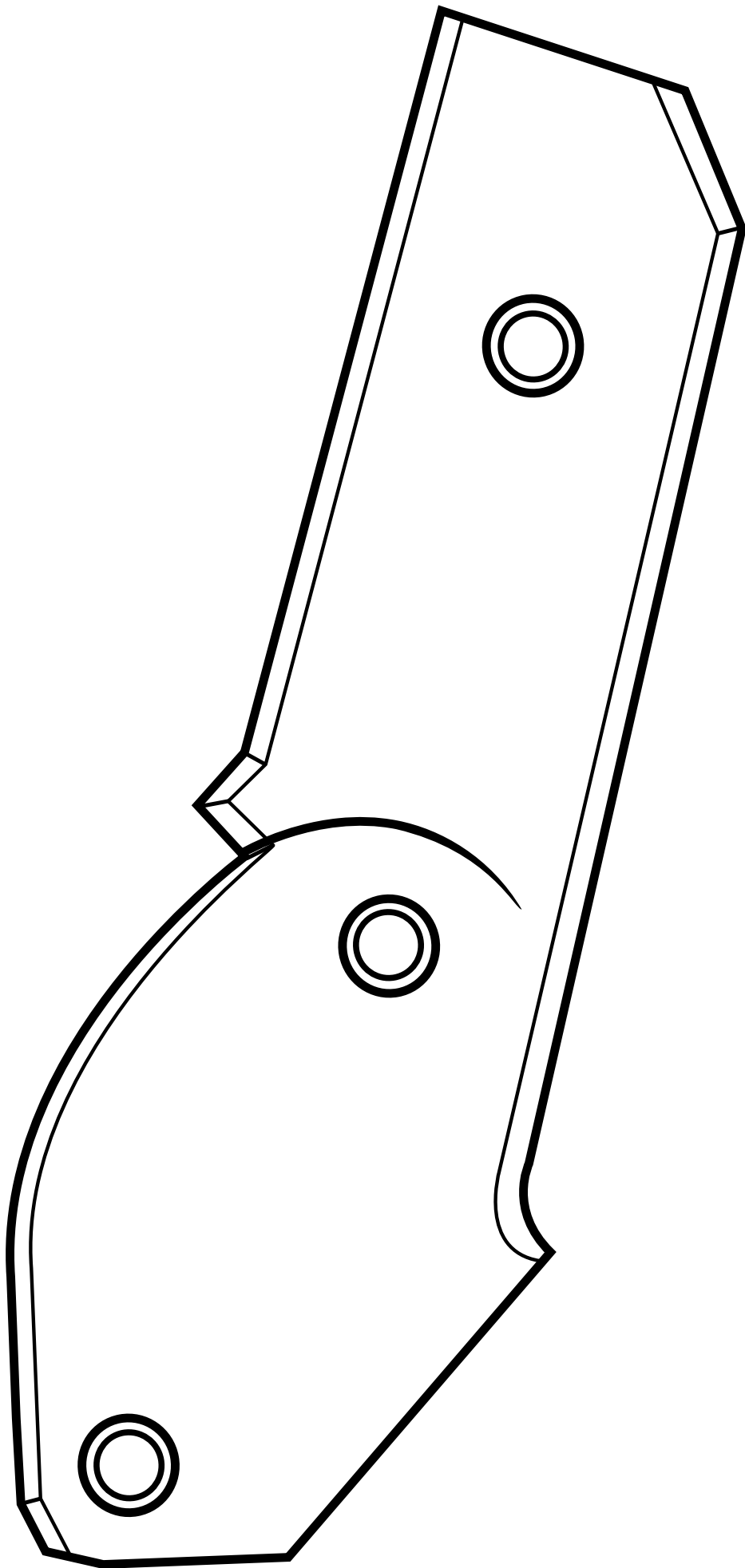

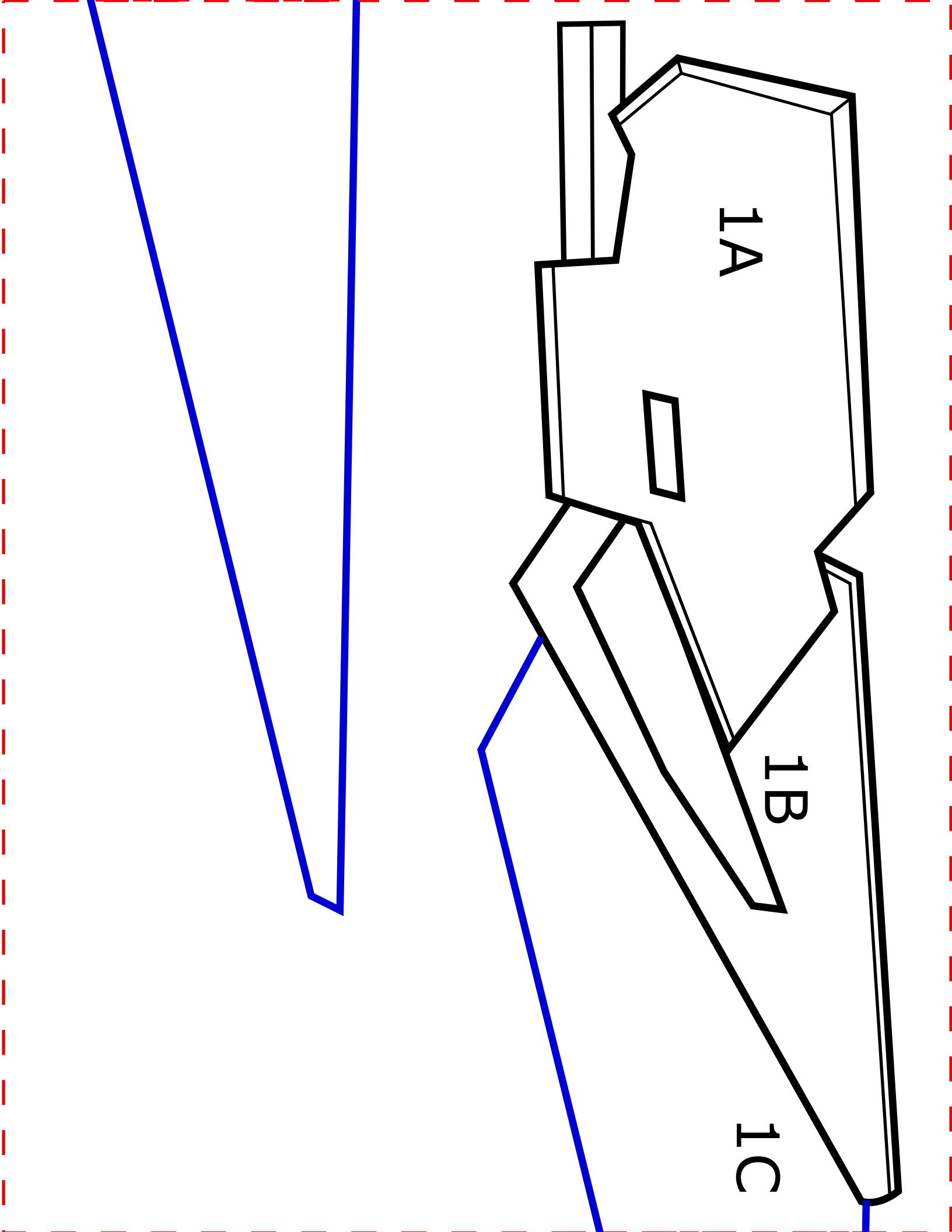

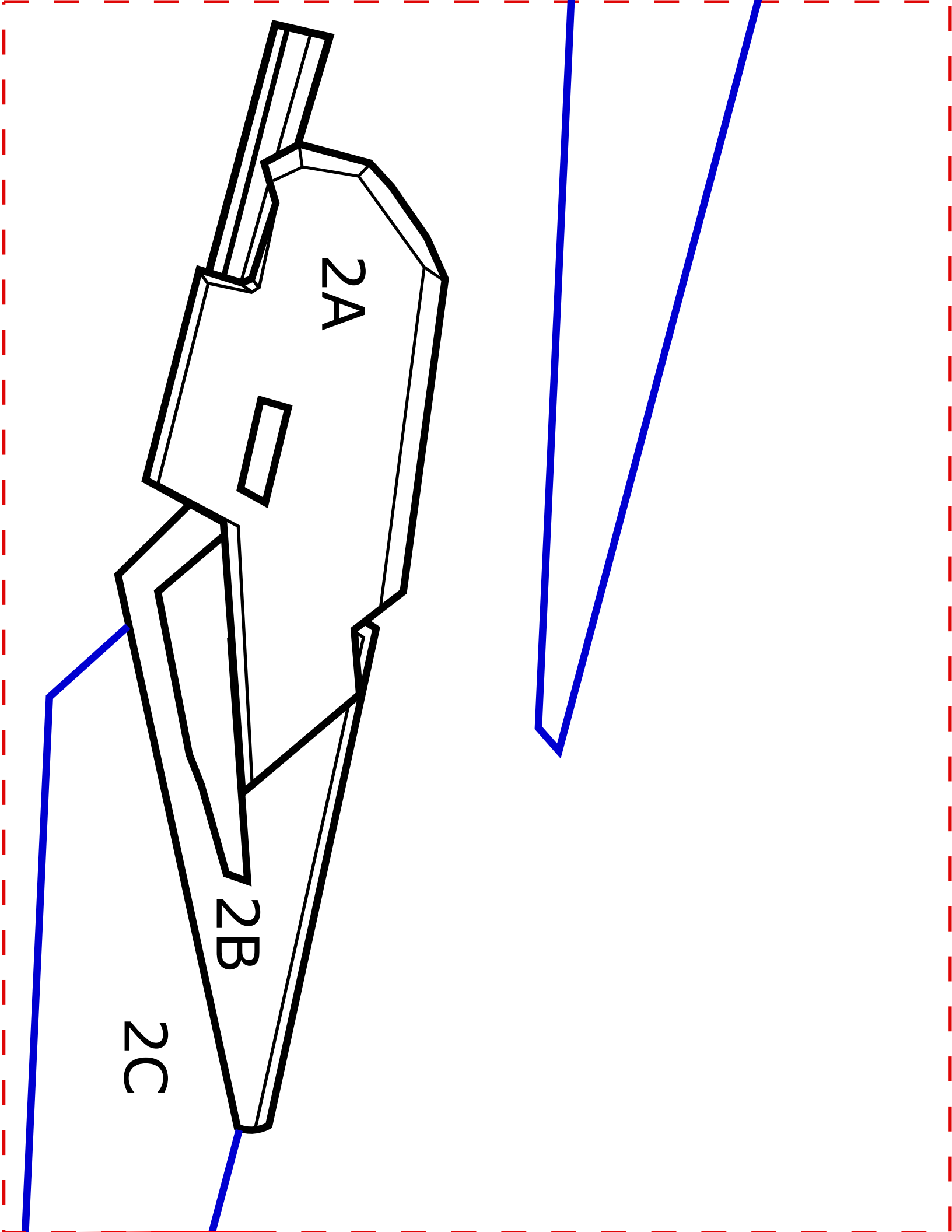

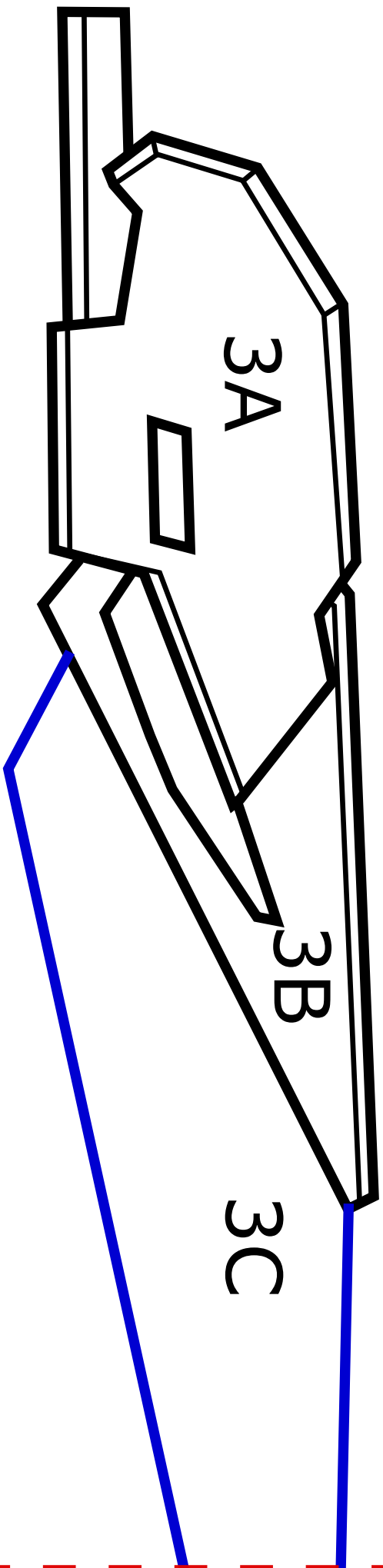

3A

3B

3C

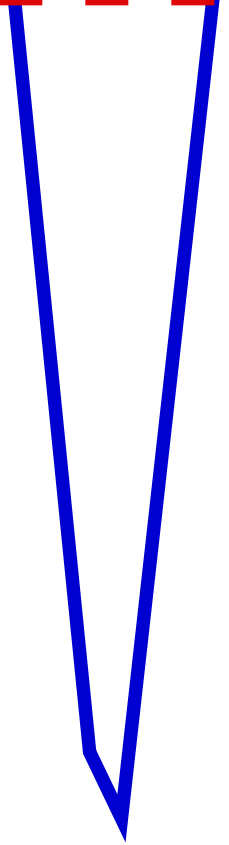
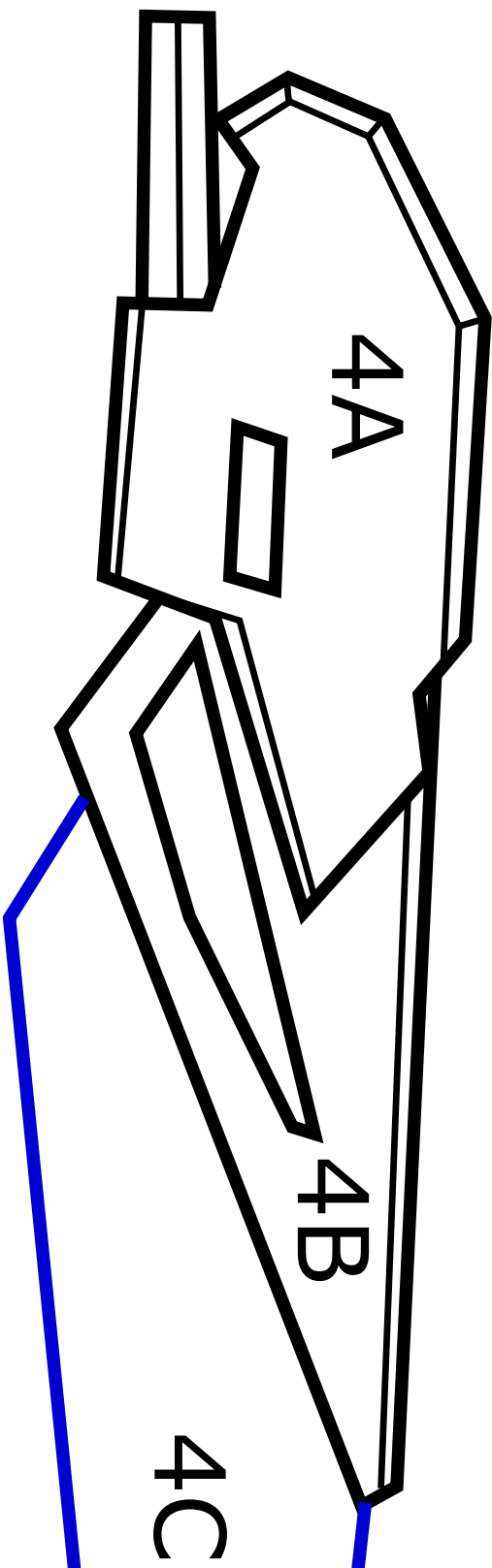



1D

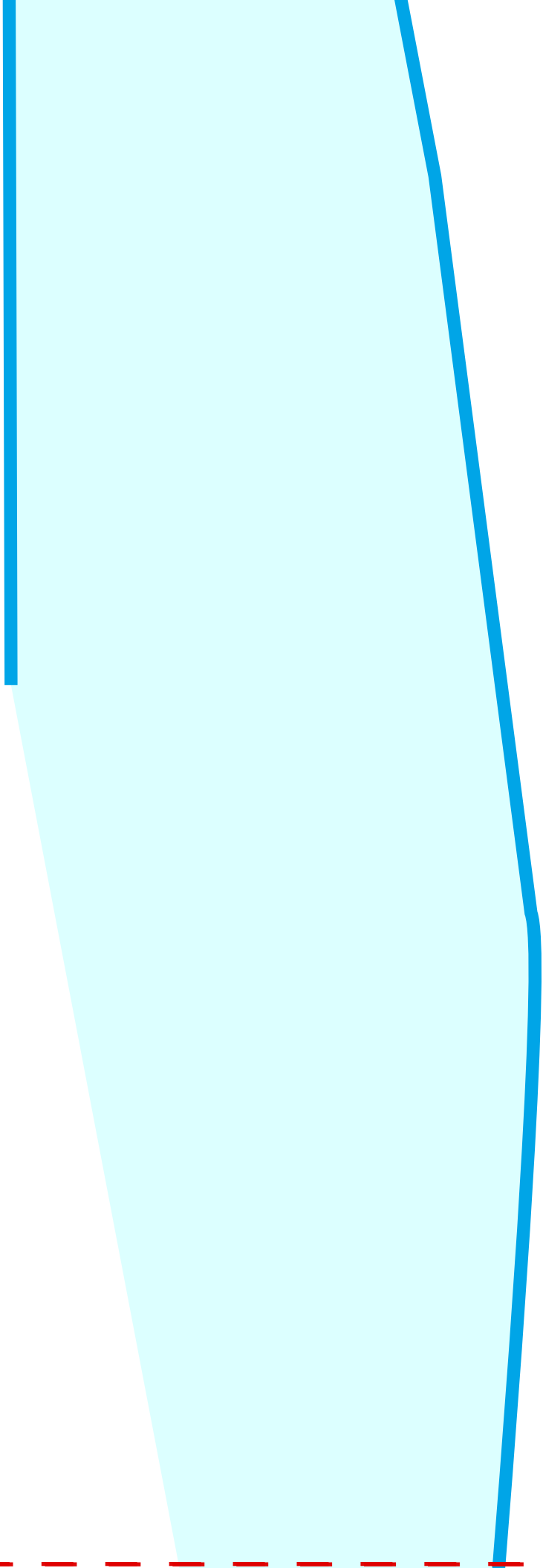

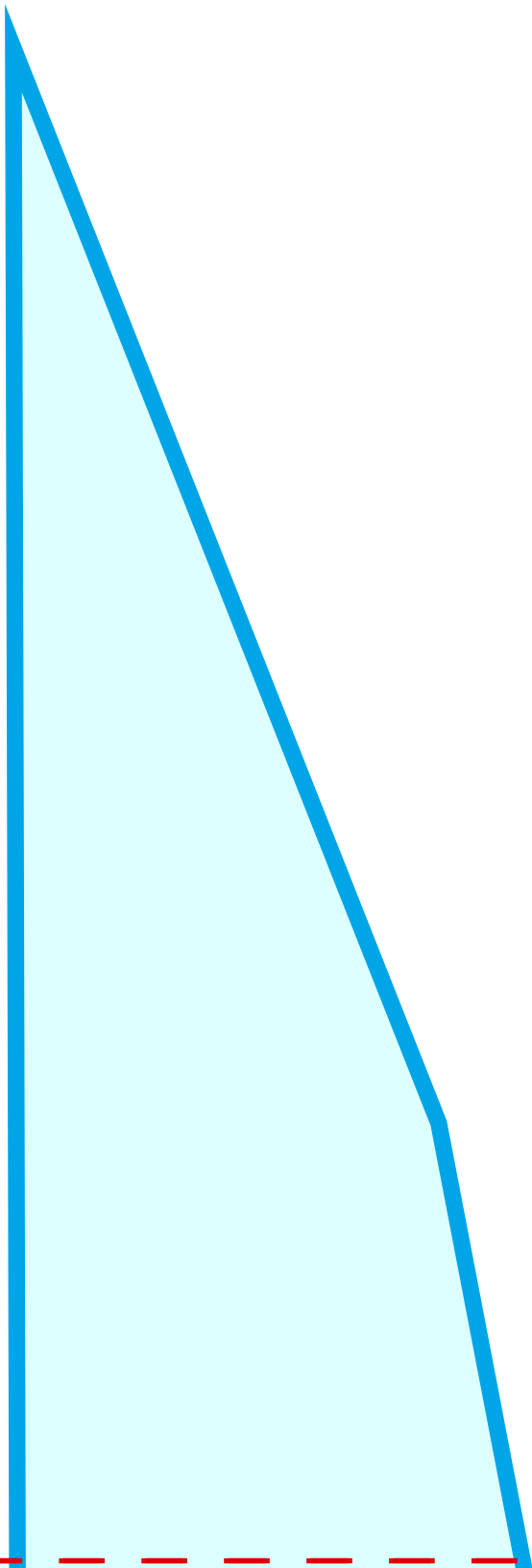

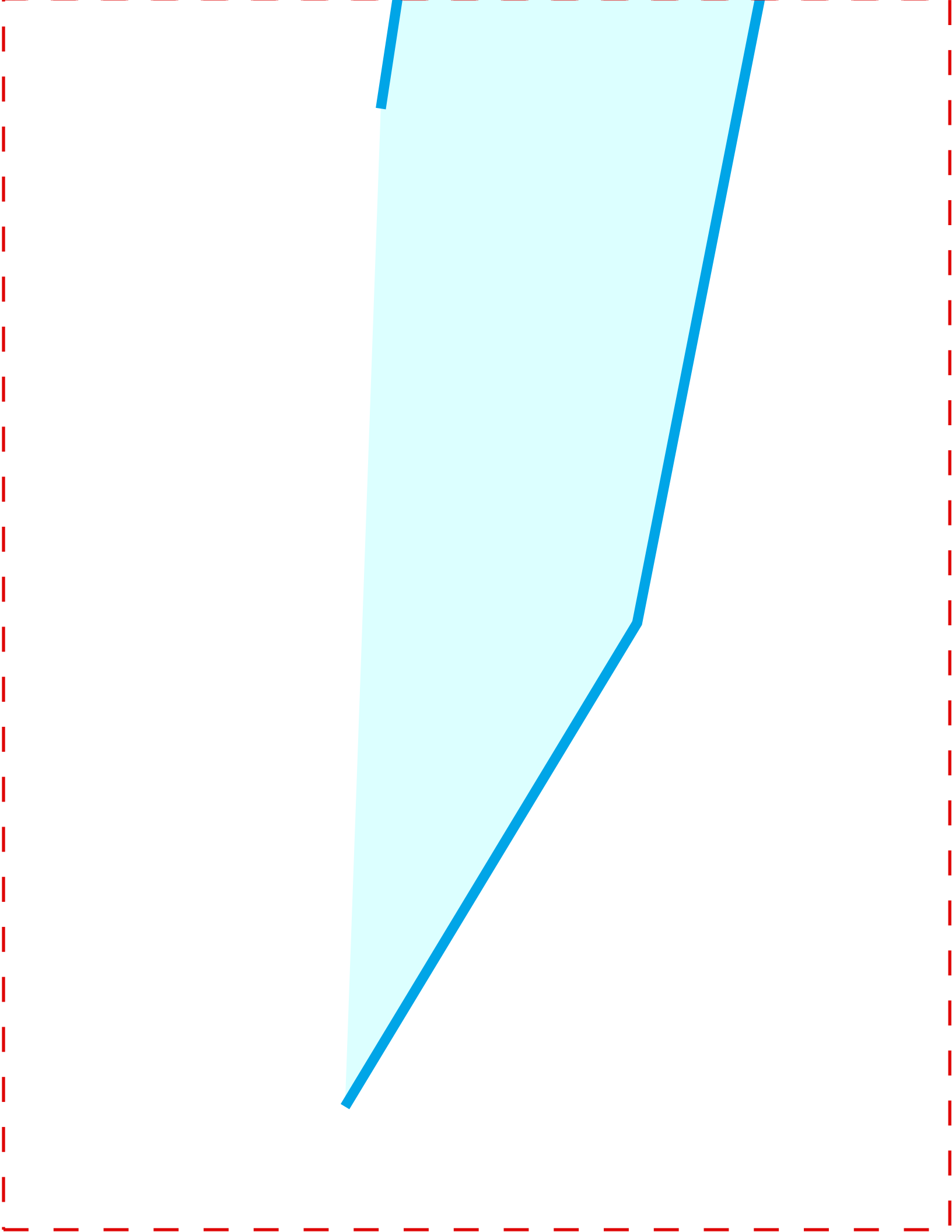



2D

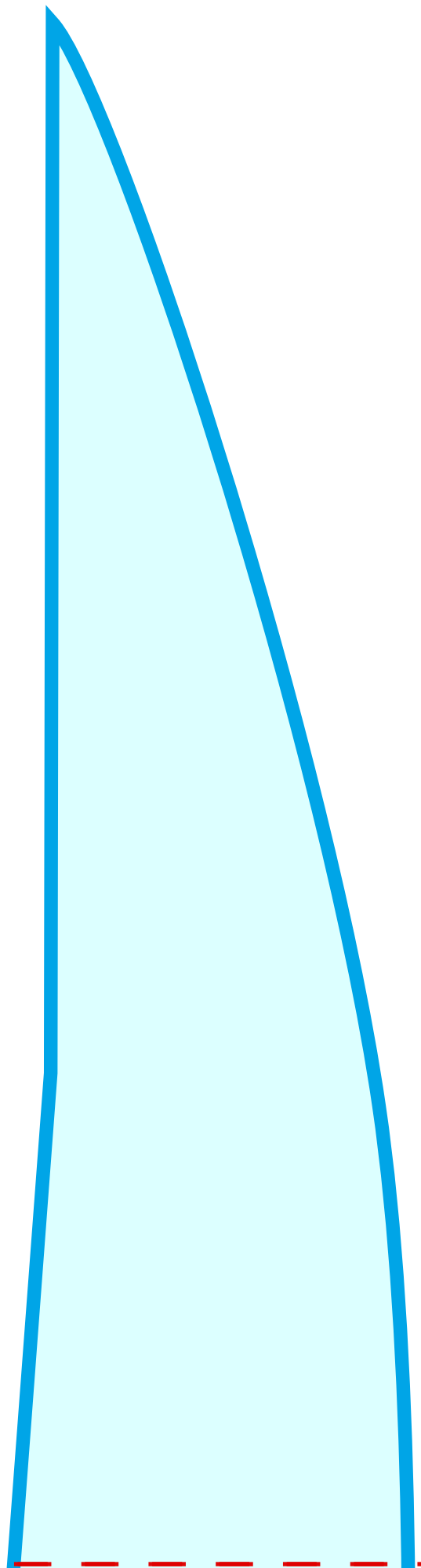

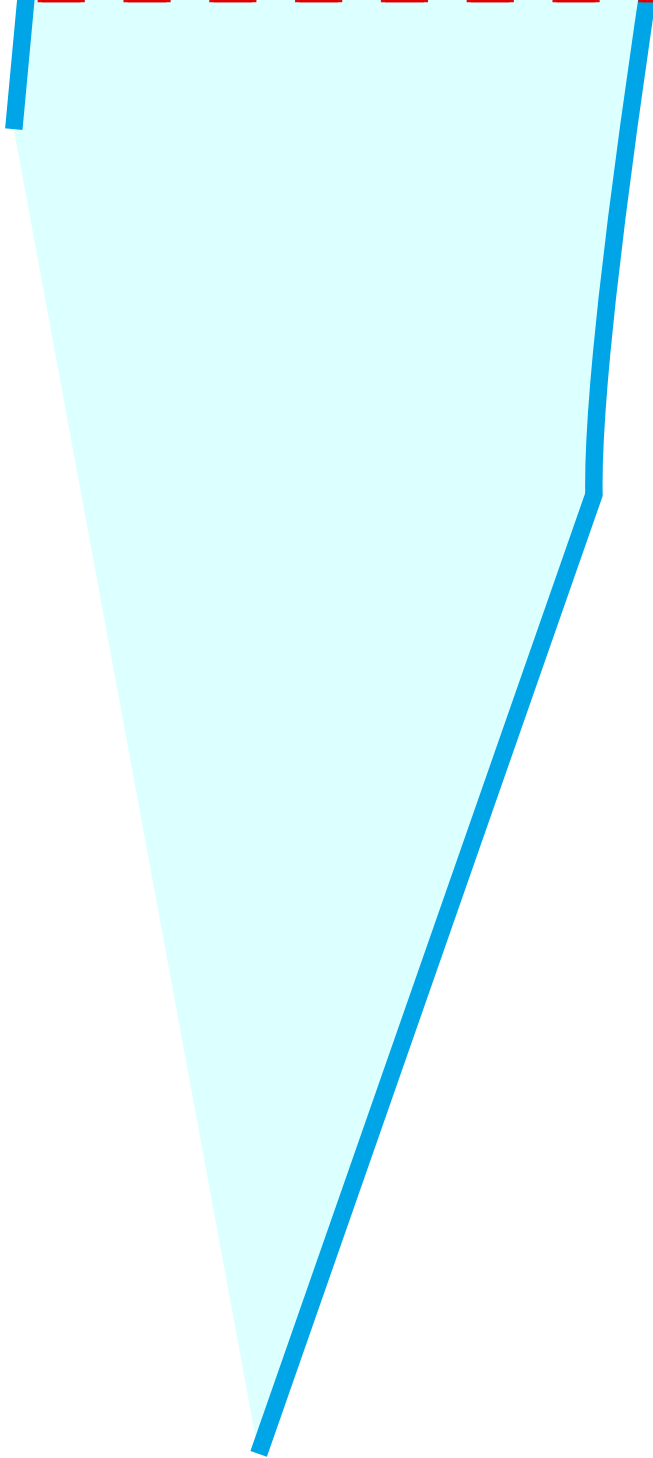



3D

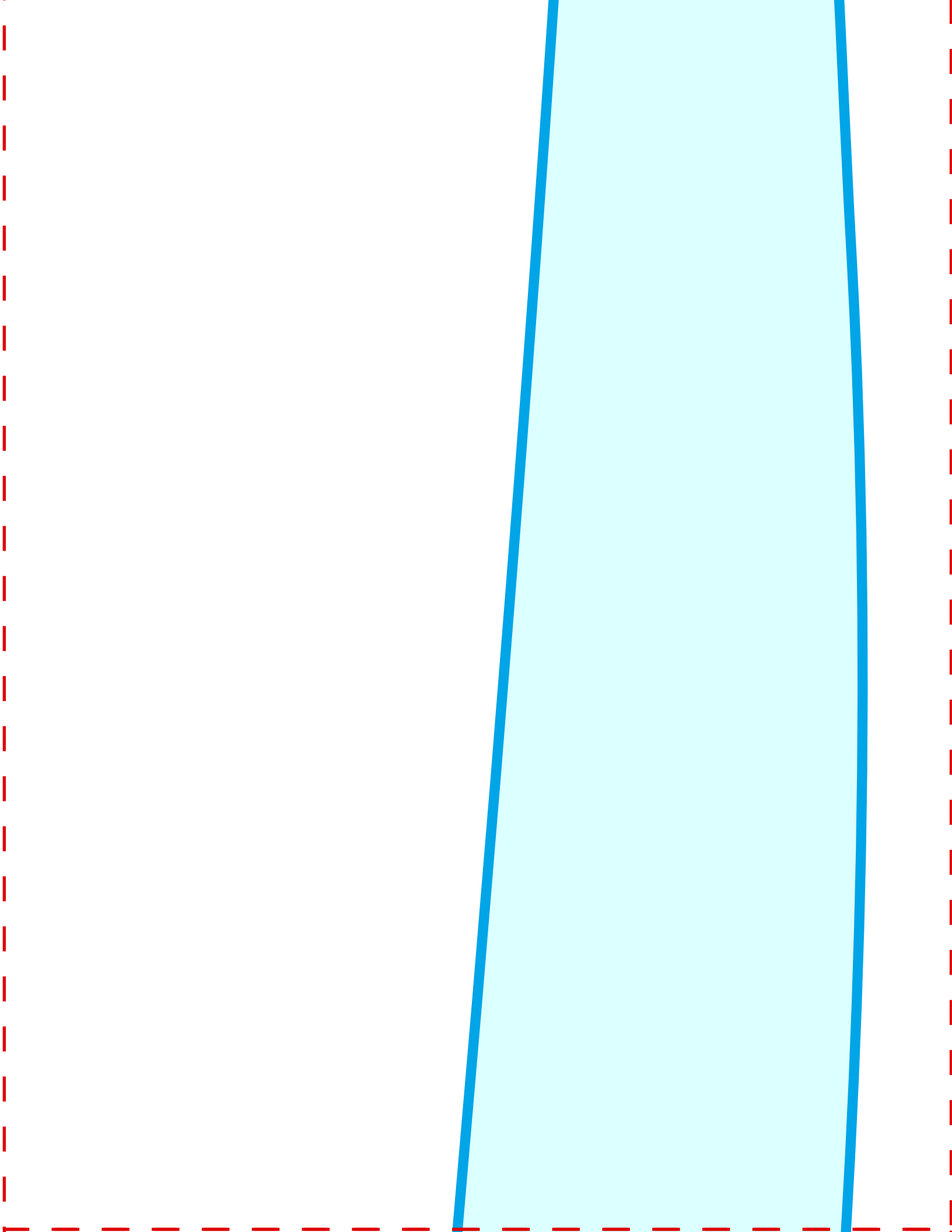

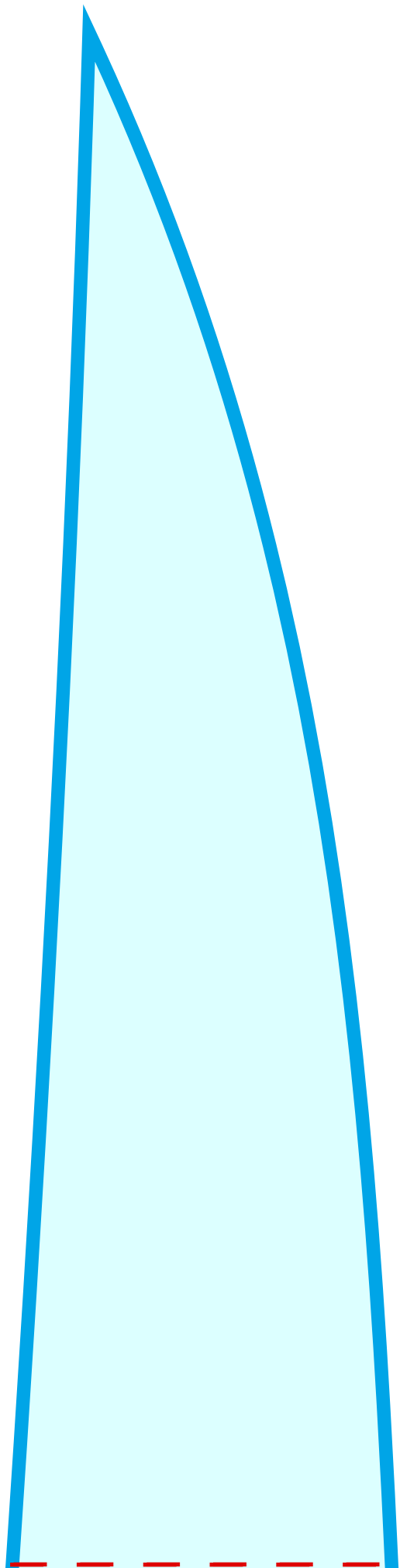

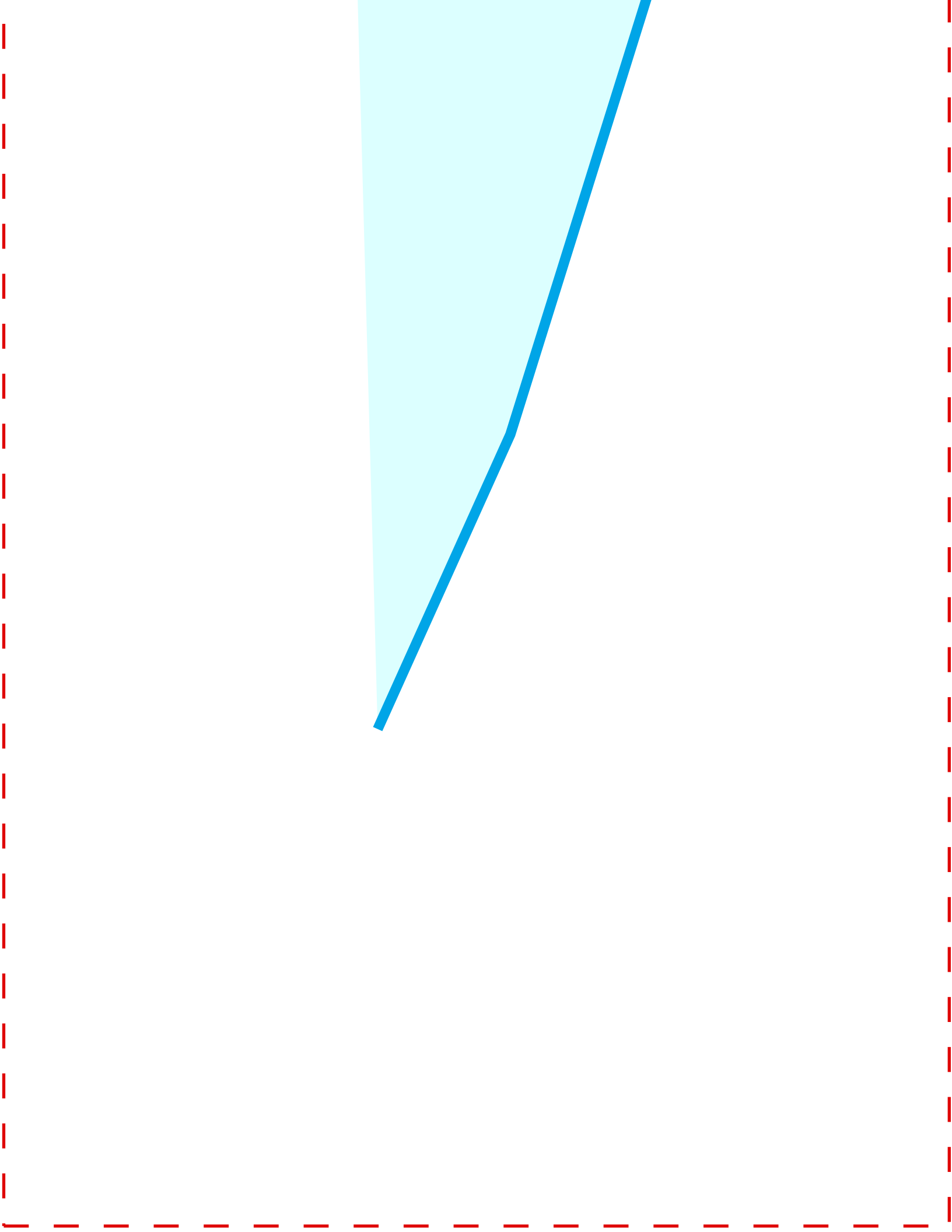

4D

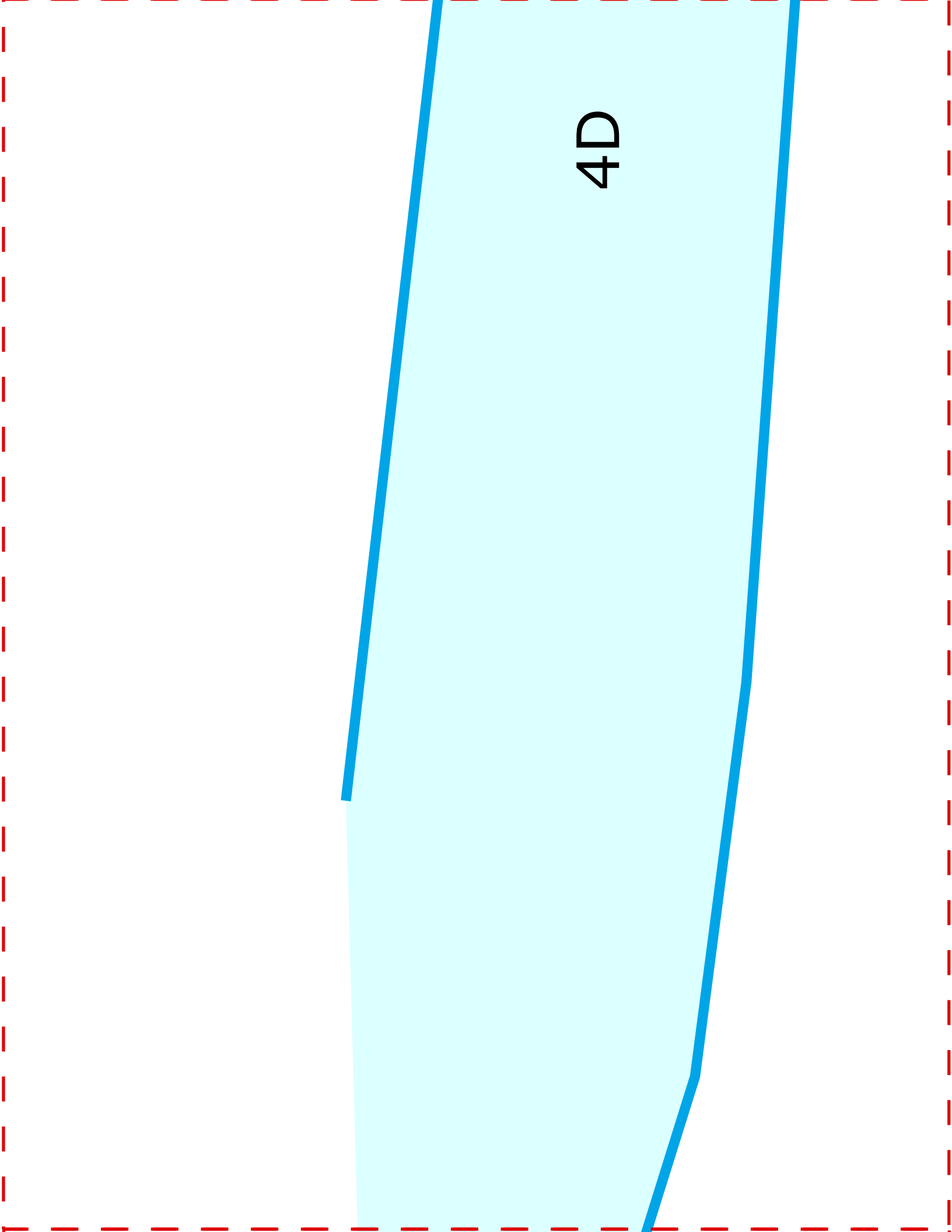

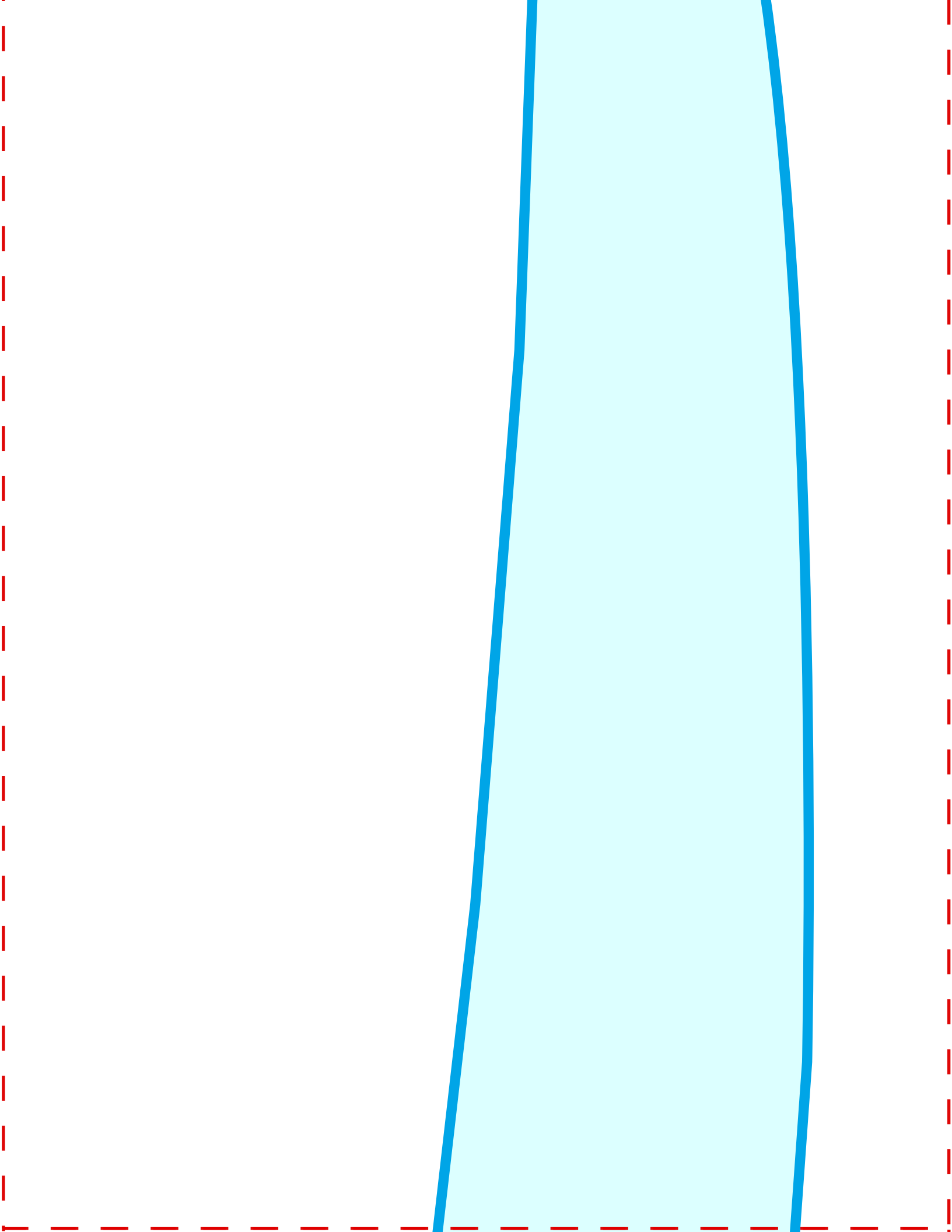

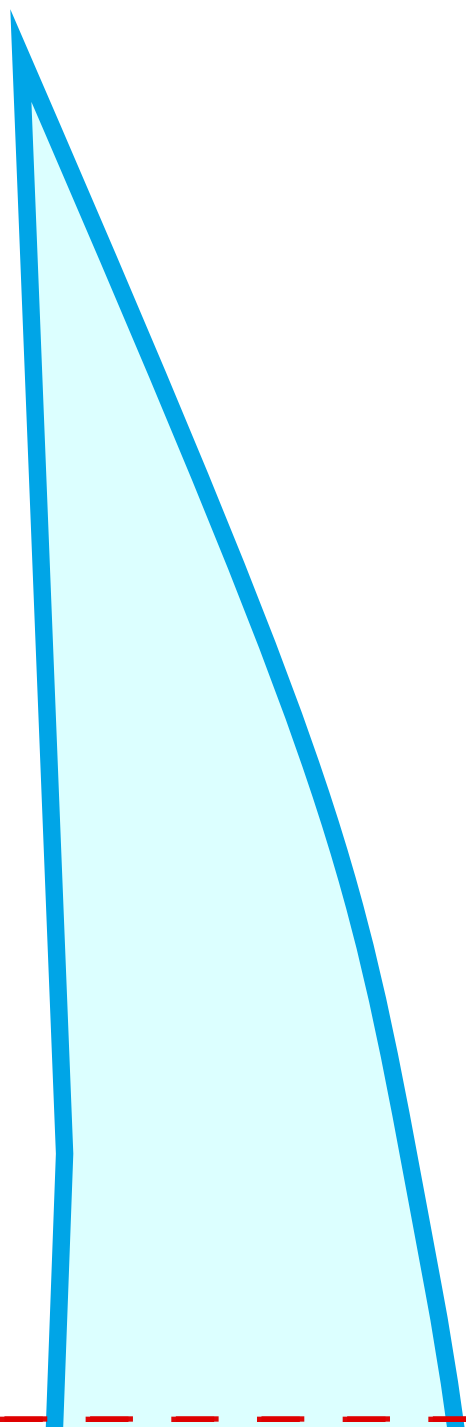

5D

Harness by Section

1:1 scale, 5'7" (1.7 m) height

If printing to A4 paper, please refer to the separate printing instructions.

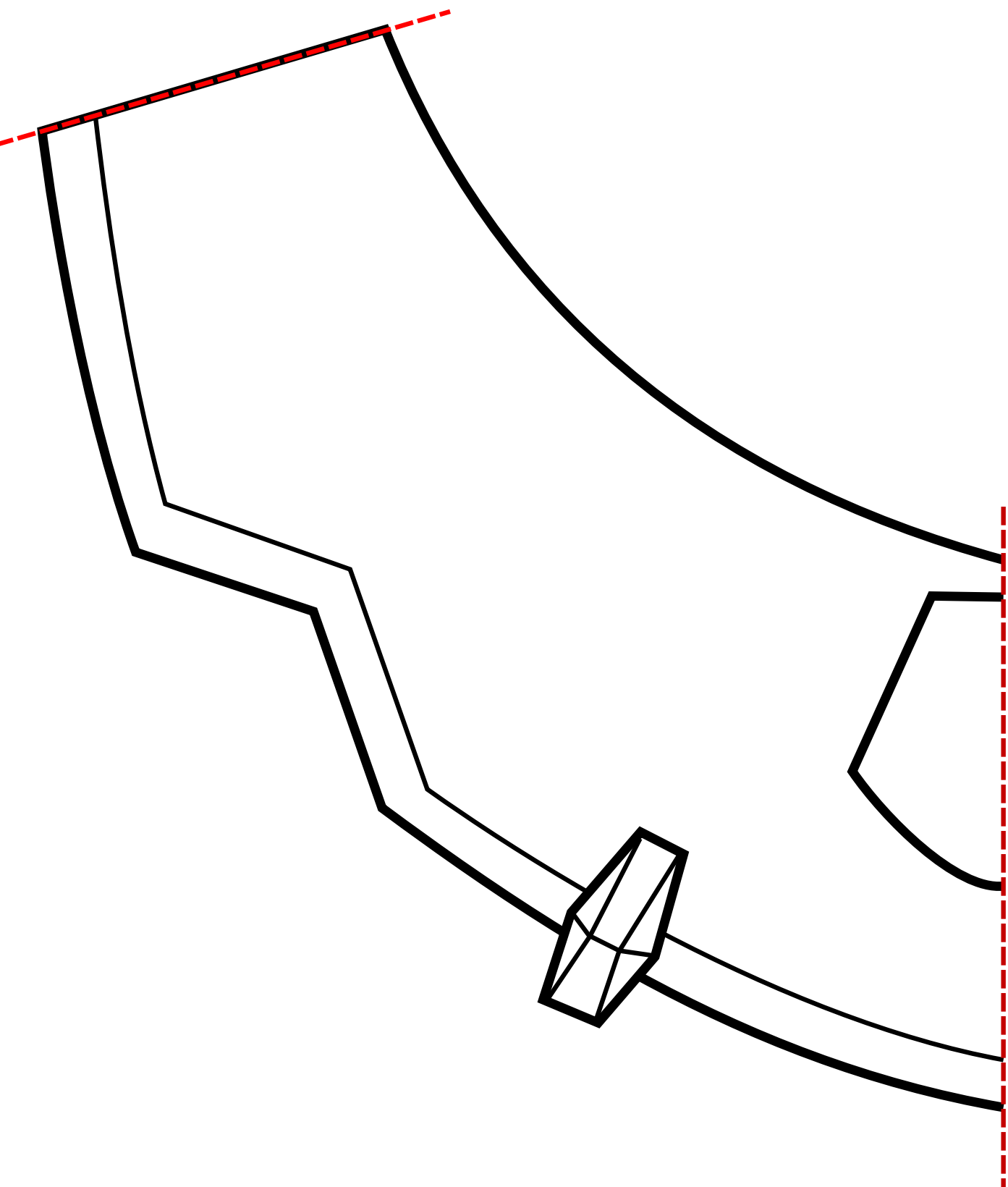

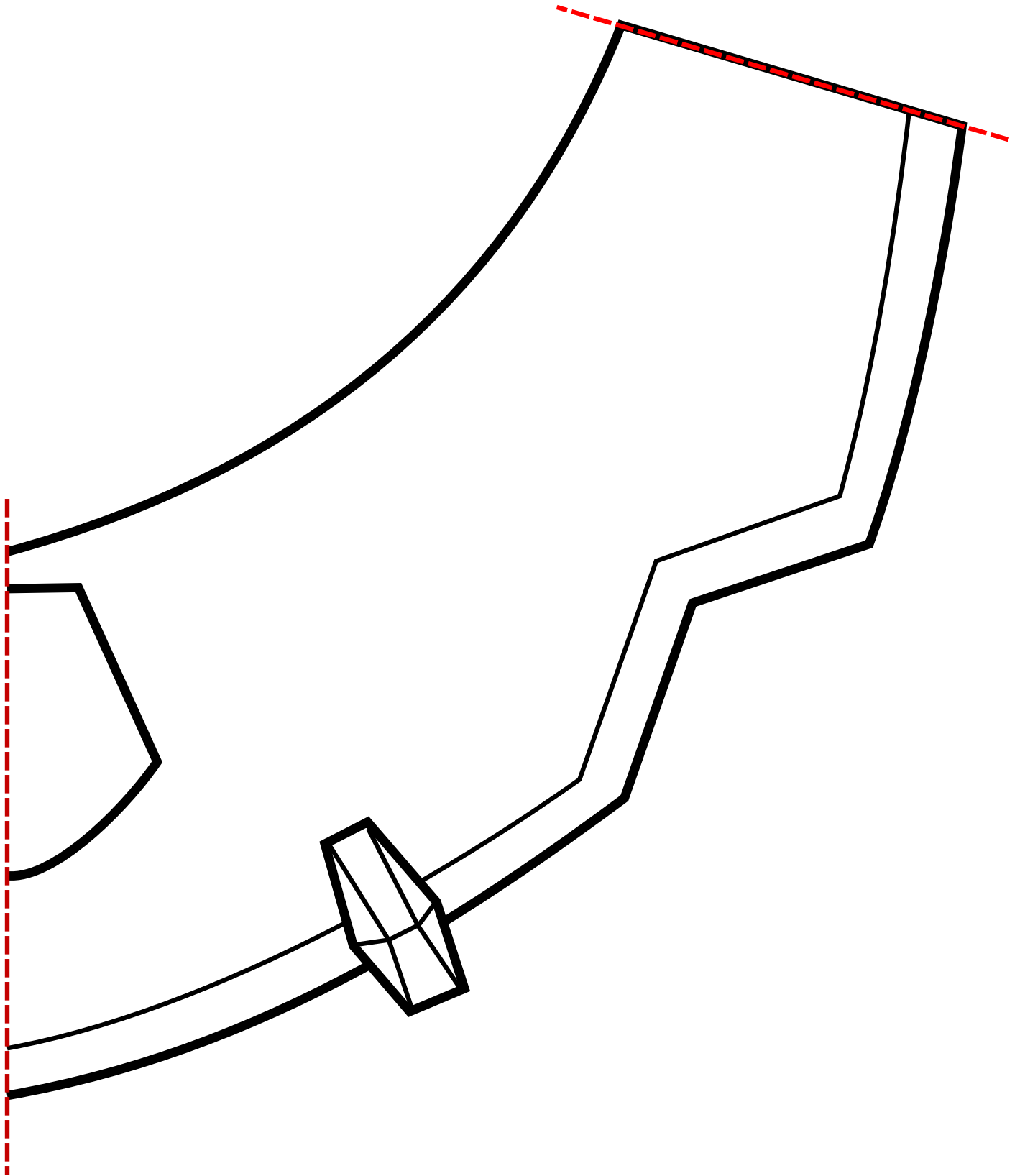

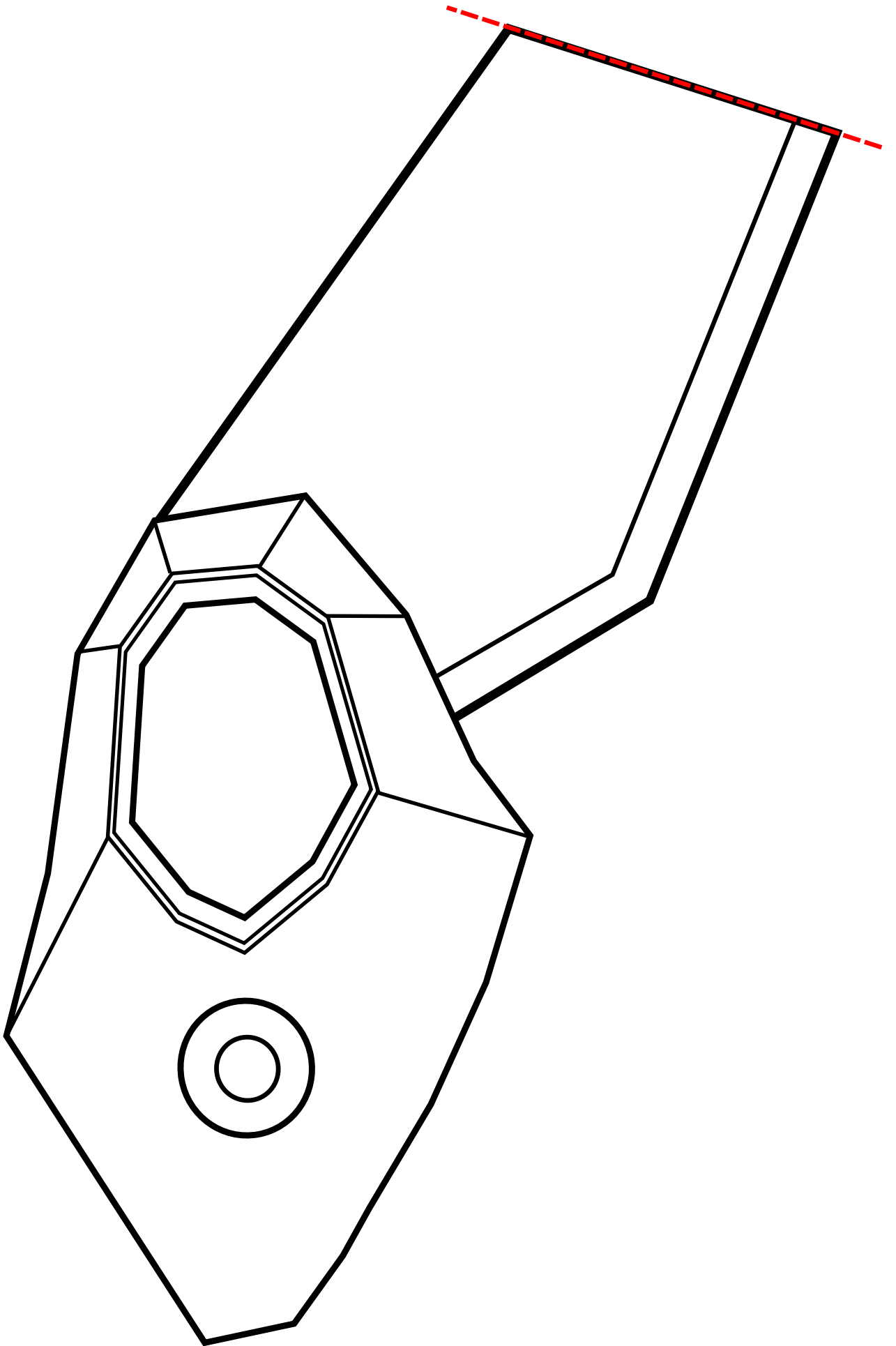

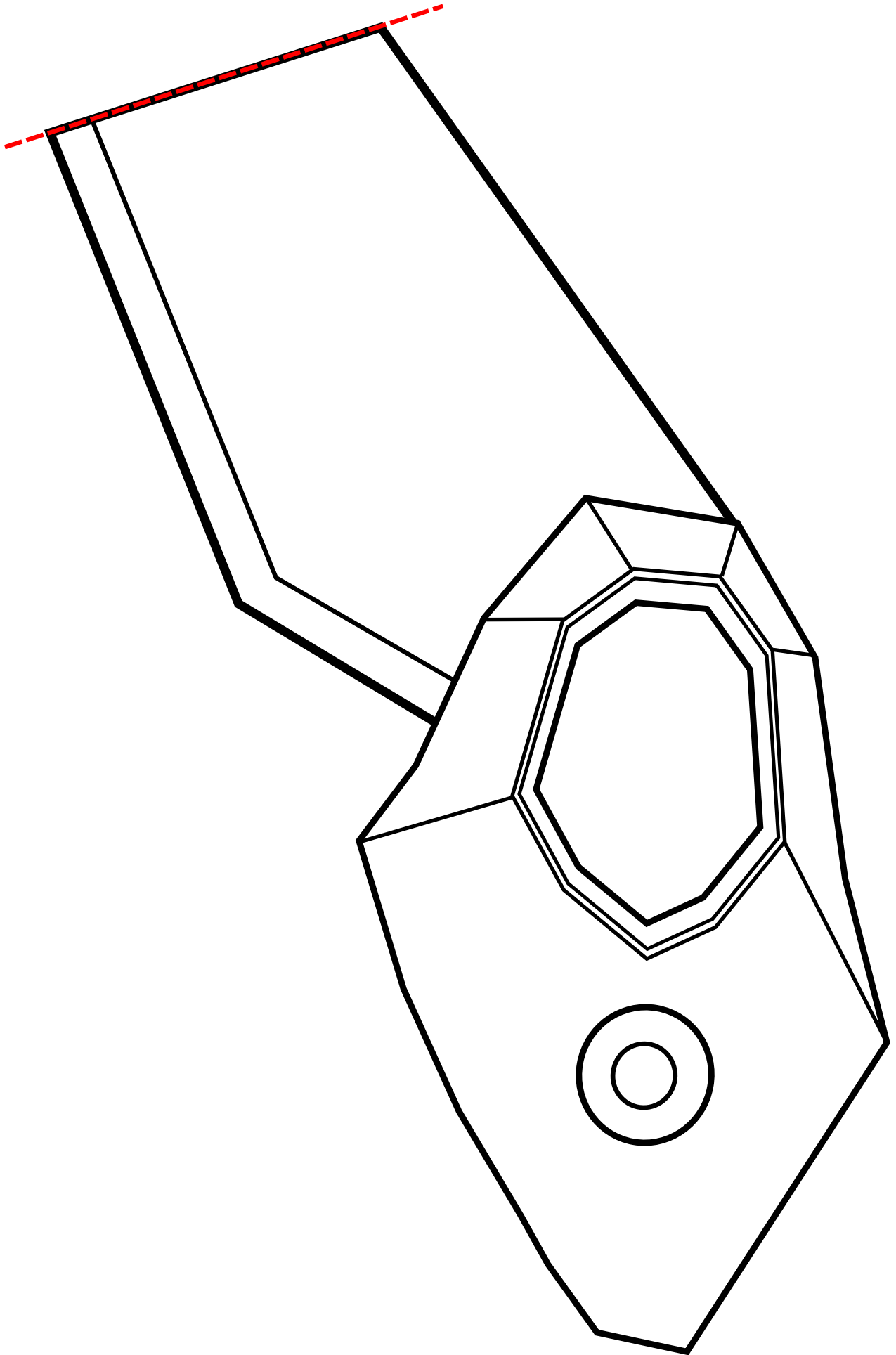

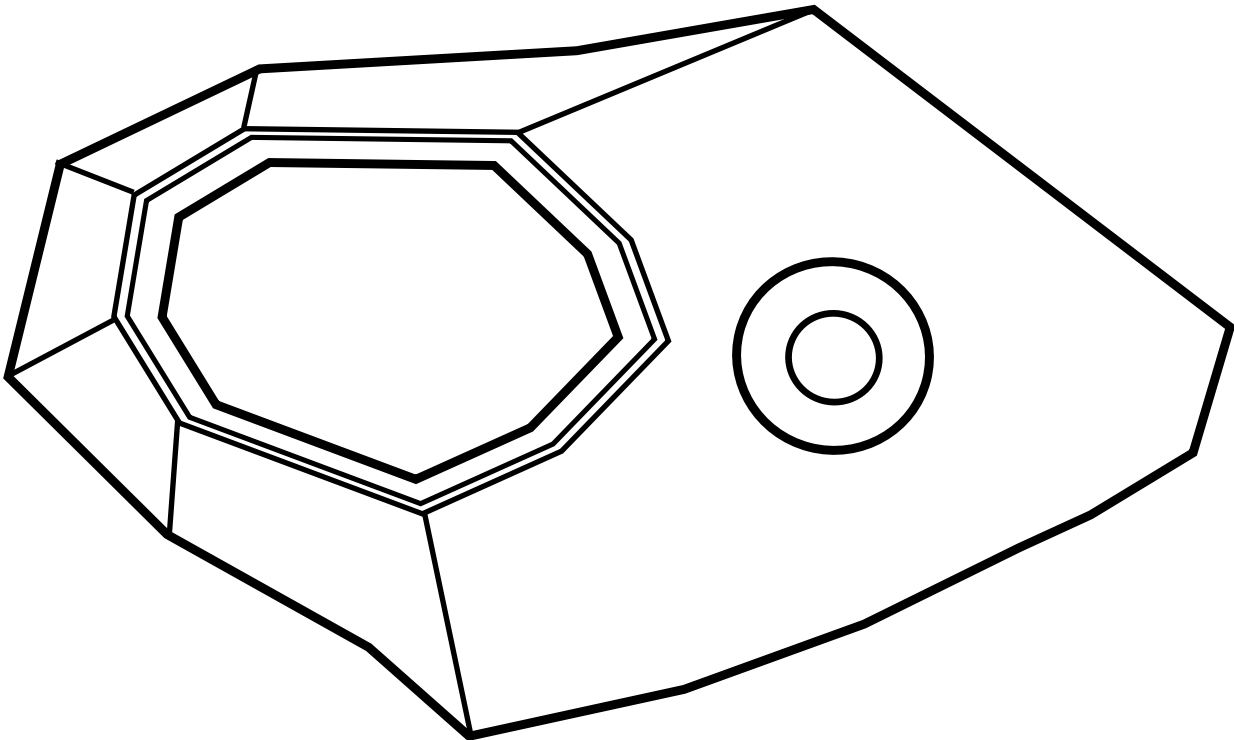
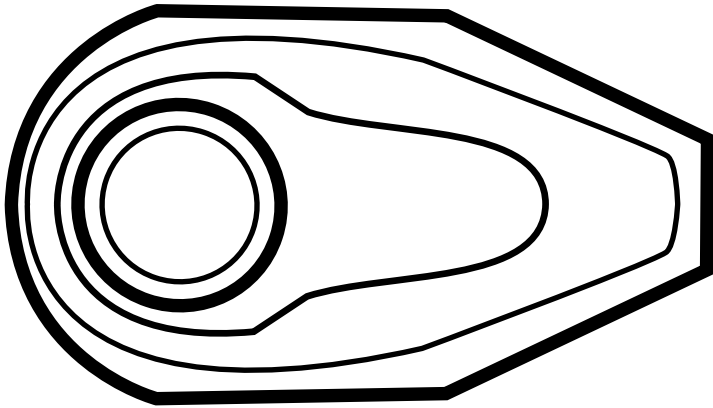
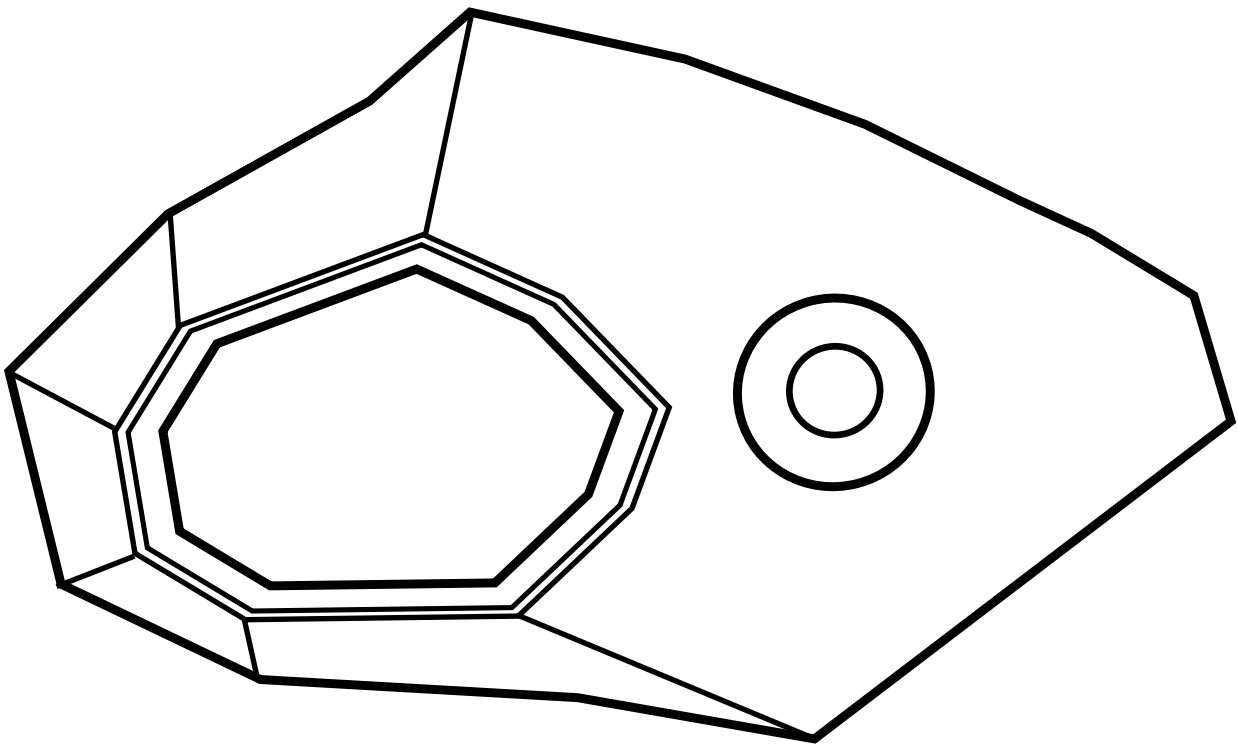

All Parts – Custom Scale

If printing to A₄ paper, please refer to the separate printing instructions.

If the original 1:1 scale does not work for your height dimensions, you can scale this pattern yourself. Refer to separate printing instructions for scaling.

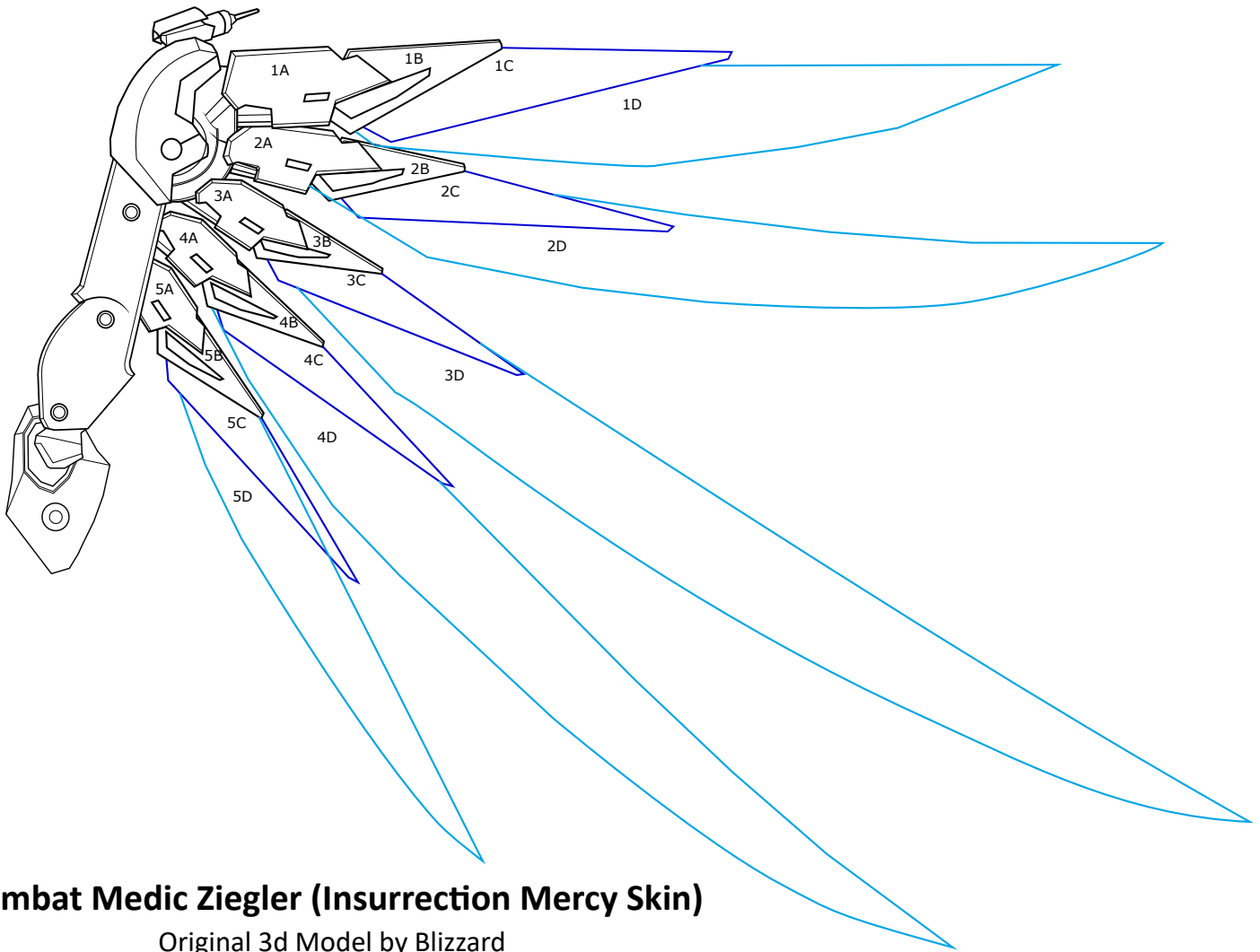

Combat Medic Ziegler (Insurrection Mercy Skin)

Original 3d Model by Blizzard
Vectors drawn by Sara McMunn



CestLaSara



Lasarabande

Note: You may need to extend the base of these wings when cutting out this page. Please cut where there are solid stroke lines below.

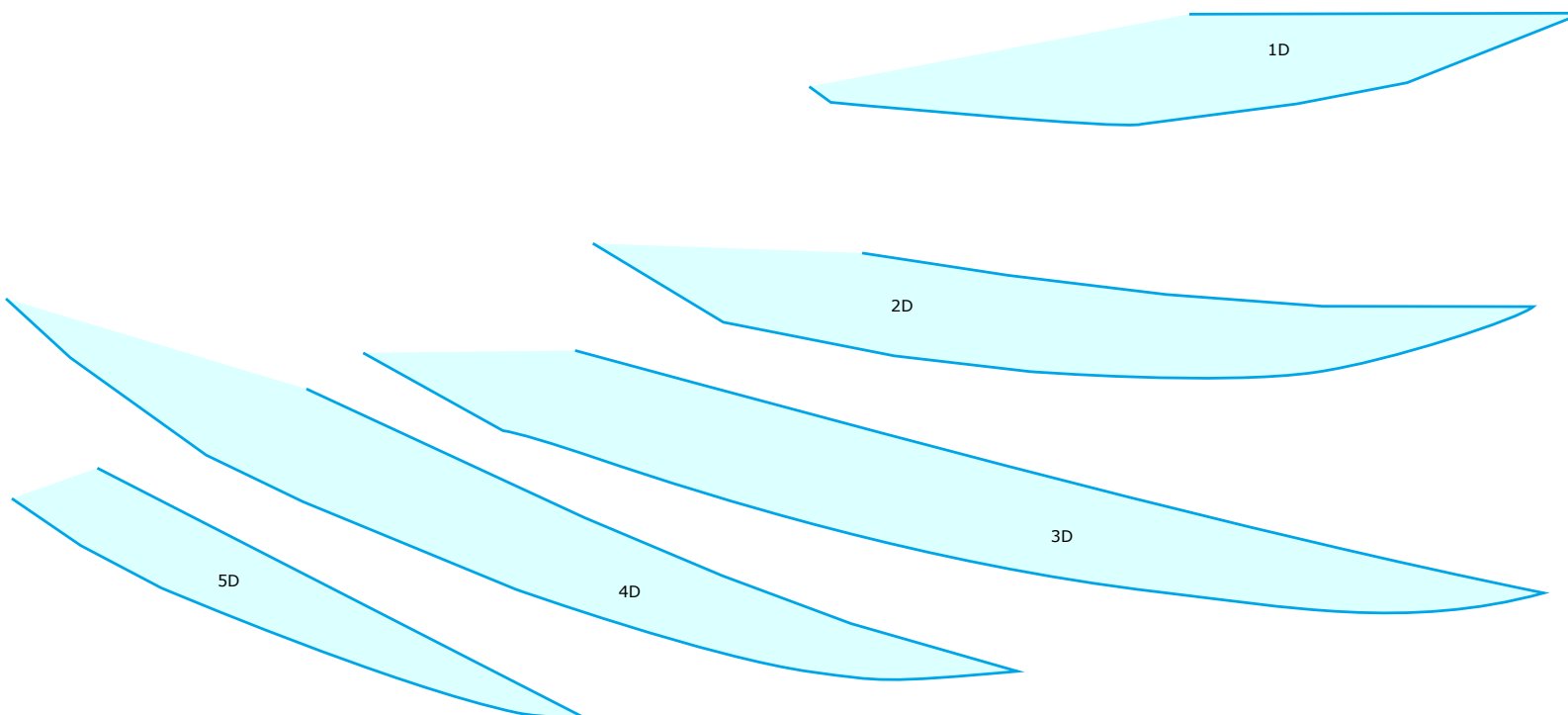

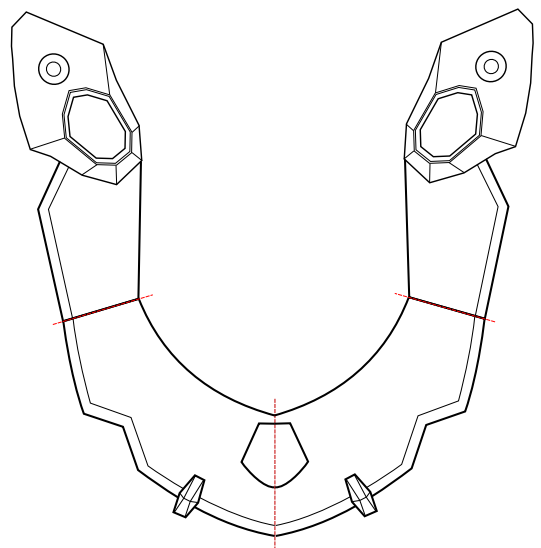
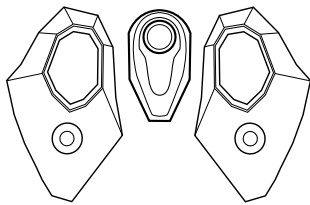
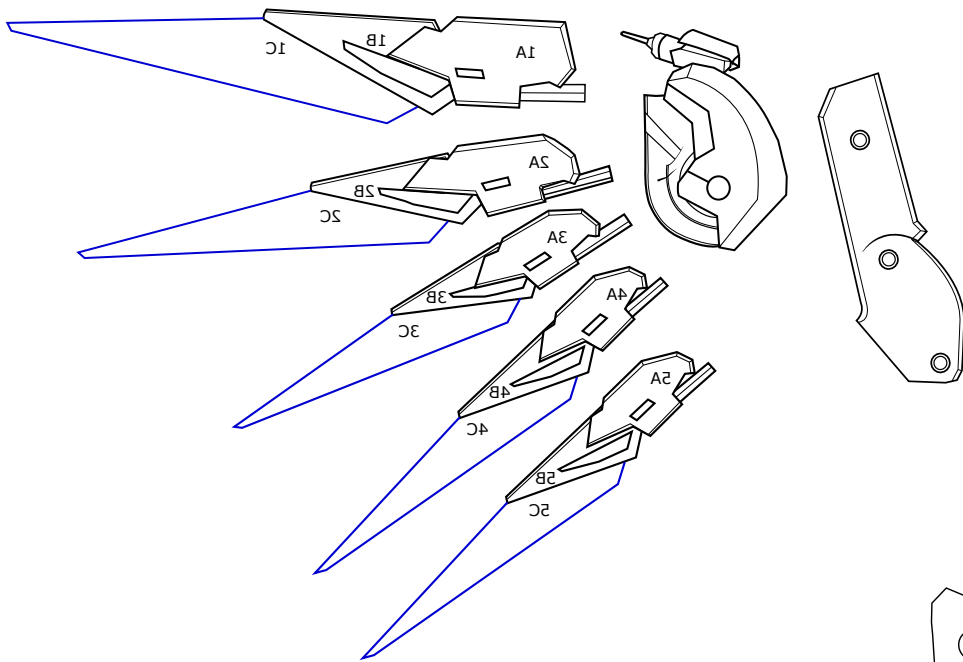

Combat Medic Ziegler (Insurrection Mercy Skin)

Original 3d Model by Blizzard

Vectors drawn by Sara McMunn



CestLaSara



Lasarabande

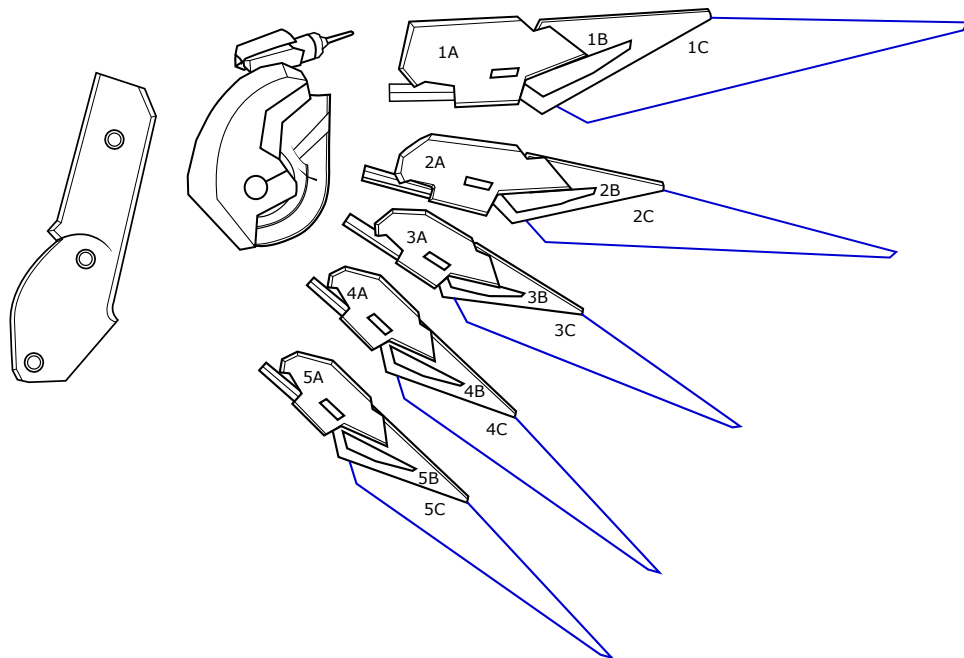

Adobe Reader DC

If Adobe does not have the option to [Tile All Pages] when printing, it may not be supported.

Below instructions apply if you have a standard office printer that usually handles letter size (8.5 x 11" paper). Otherwise if you have a large scale printer, you will need to consult your printer's manual or adjust the scaling according to your large scale printer's settings.

1. Open your PDF file with Adobe Reader DC
2. Click File > Print

Refer to image below

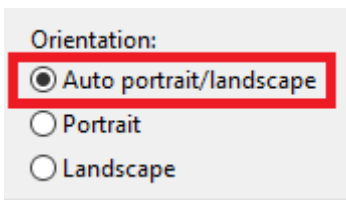

On the bottom, set your orientation to **Auto portrait/landscape**

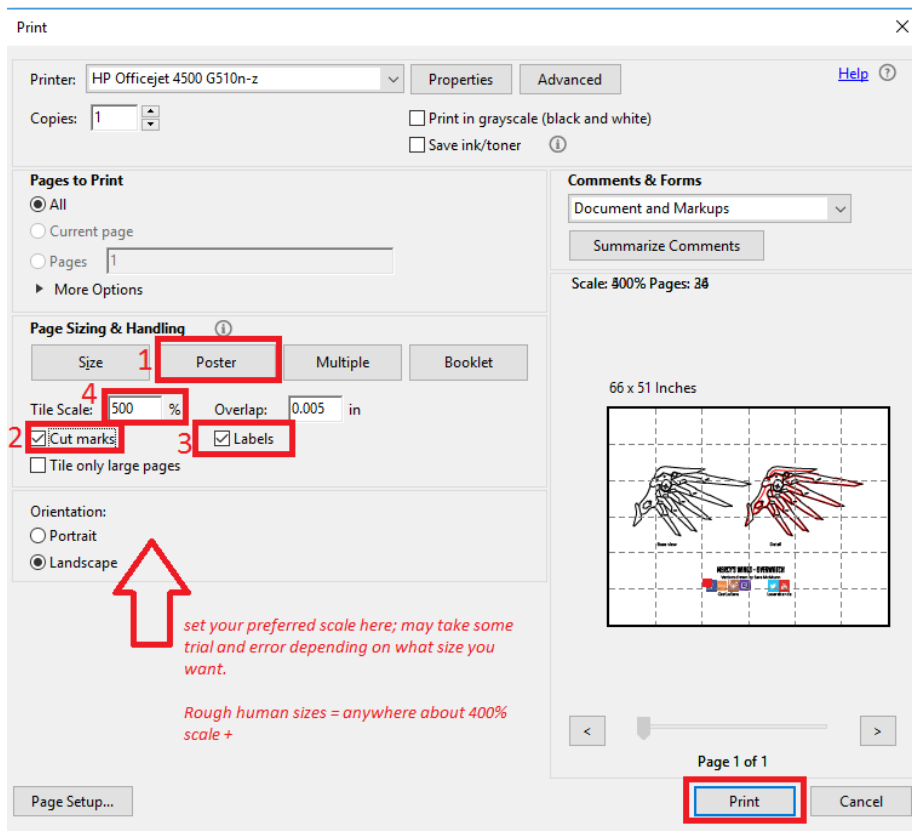

Adobe Acrobat / Reader X

If Adobe does not have the option to [Tile All Pages] when printing, it may not be supported.

Below instructions apply if you have a standard office printer that usually handles letter size (8.5 x 11" paper). Otherwise if you have a large scale printer, you will need to consult your printer's manual or adjust the scaling according to your large scale printer's settings.

1. Open your PDF file with Adobe Acrobat / Reader
2. Click File > Print

Refer to image below

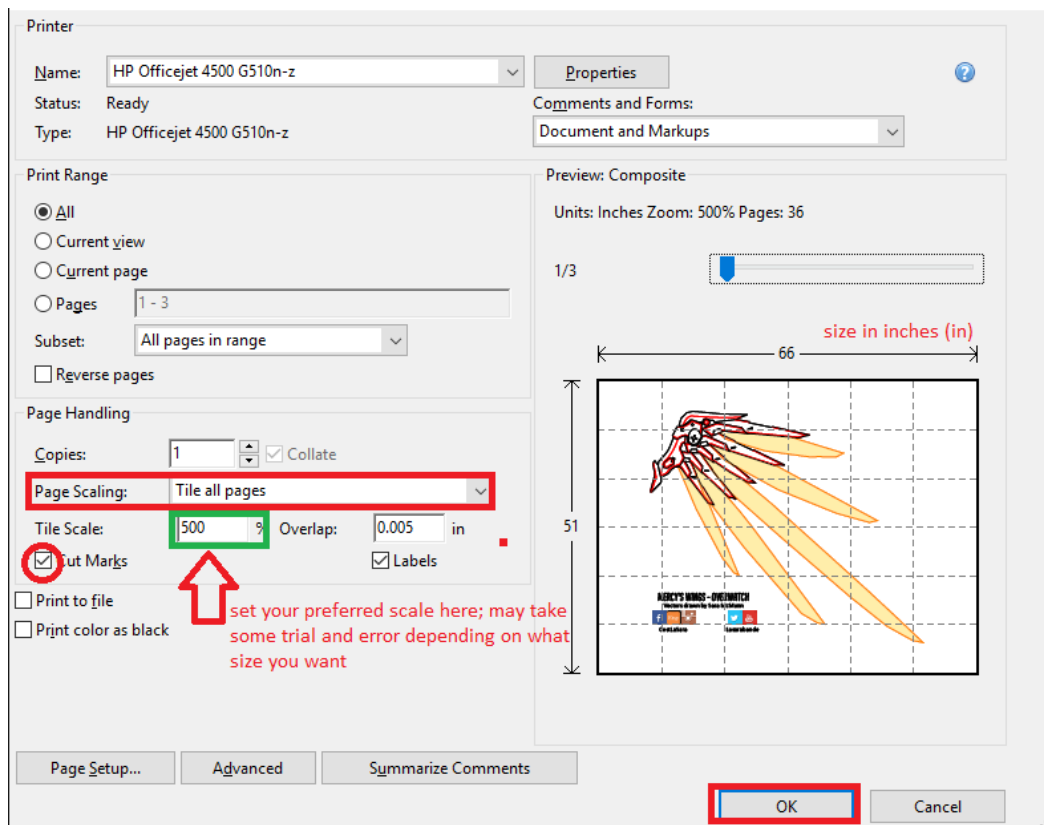

Set Page Scaling to [Tile all pages], then experiment as to how much you want your scale to be under [Tile Scale %, in green]. Results may vary as no two body sizes are the same.

For more information, please visit: <https://helpx.adobe.com/acrobat/kb/print-posters-banners-acrobat-reader.html>

Feel free to contact me on my social media pages if you have any questions!



CestLaSara



Lasarabande